

US Product Catalog

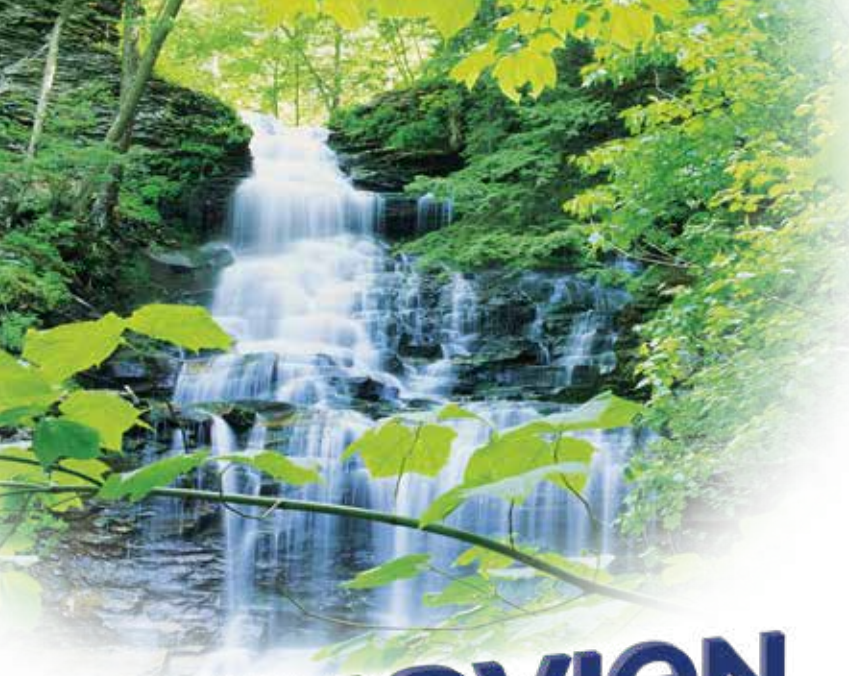

April 2023



Innovation,
advanced technology
and solutions for
a greener world

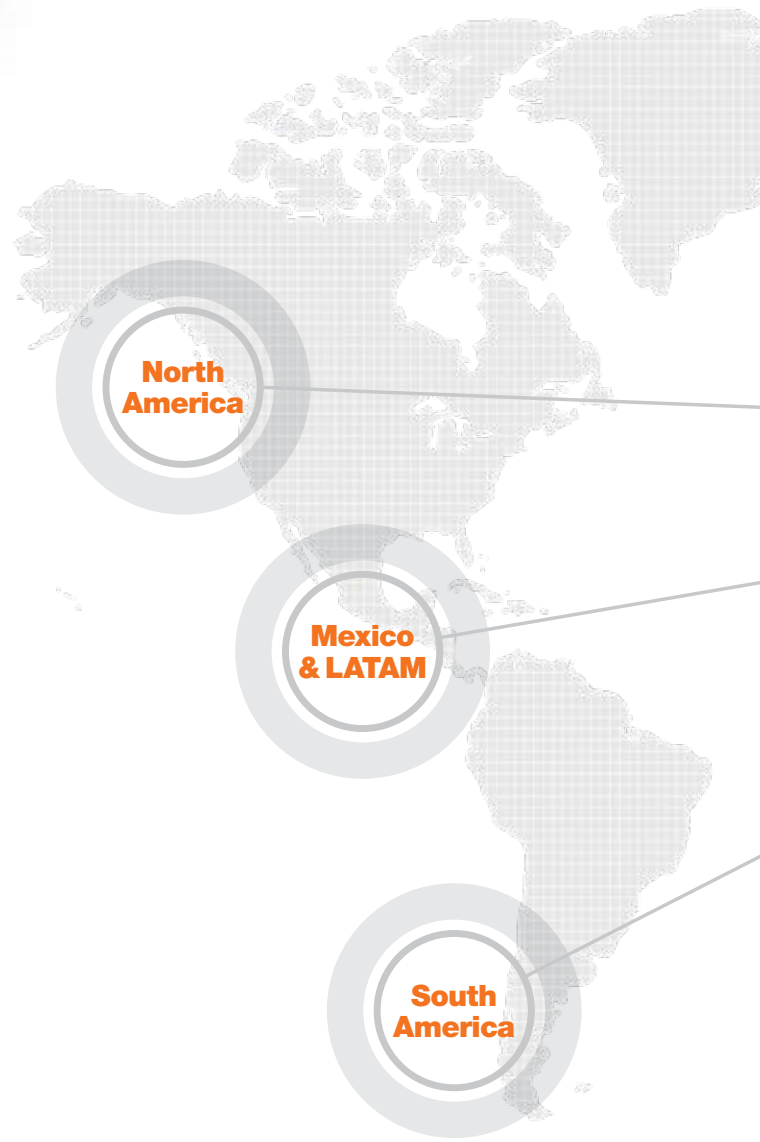

Navigating, energy and environment

Three words from which the company name was created.

Mission

To provide customers with the ultimate comfortable living environment through energy efficient products by using innovative technology to create a healthier environment for our future generations.

Global vision

Navien retains the largest market share for condensing gas water heaters in North America; is ranked top in technology patents; and is the largest exporter of boilers from Korea. Navien proudly exports that leadership in dependability, design, green technology, social responsibility and customer service to over 30 countries.

A world leader in energy efficient technology

Navien was an early leader in developing condensing technology for boilers and water heaters. Condensing technology maximizes energy by using heat emitted from flue gasses. As a result, energy consumption and greenhouse gases are reduced.

Advanced technology for a cleaner world

Navien's high efficiency and eco-friendly technology has reduced energy consumption by 20% and cut down the emissions of greenhouse gases. Our condensing tankless gas water heaters achieved one of the industry's highest energy factors, 0.96 UEF.





Europe

Russia

Asia

Oceania



Solutions to control Navien products from anywhere in the world

Navilink® Wi-Fi remote control system. This add-on accessory enables customers with smartphones and tablets to control their units remotely.

NPE-2 Series

Pages 4-11



NPE-2

NPN Series

Pages 12-17



NPN

NCB-H Series

Pages 18-23



NCB-H

NFC-H Series

Pages 24-29



NFC-H

NHB Series

Pages 30-35



NHB

NFB-H Series

Pages 36-41



NFB-H

NFB-C Series

Pages 42-47



NFB-C

PeakFlow Filtration Systems

Pages 48-49



PeakFlow®

NPE-2 PREMIUM EFFICIENCY CONDENSING TANKLESS WATER HEATERS

Navien...the proven leader in condensing tankless, makes it even easier to sell, install and set up with new NPE-2 Series

Cuts installation time in half

Thanks to using 1/2" gas pipe and 2" PVC venting, you can install a Navien tankless water heater in about half the time as competitive tankless heaters. Not to mention, Navien EZNav™ intuitive controls with setup wizard makes startup a simple and fast process.

Fewer callbacks, longer life, faster heating

Navien was first to offer durable dual stainless steel heat exchangers.

Saves energy, easier on the planet

Navien condensing stainless steel heat exchangers recover extra heat that would be lost in non-condensing units. Lower CO₂ emissions and low exhaust temperatures allows for less expensive venting materials like schedule 40 PVC.

ComfortFlow®

NPE-A2 built-in recirculation system

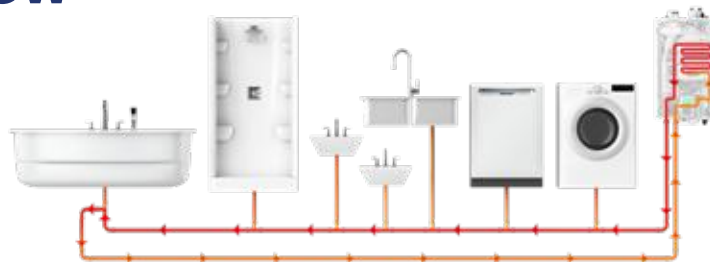

Navien's patented ComfortFlow® system is the first to include a buffer tank, recirculation pump and fine-tuned controls into a tankless water heater, resolving the cold-water sandwich effect* and issues of minimal flow rates commonly found in other tankless water heaters.

*The "cold-water sandwich effect" is the undesired introduction of cold water into the hot water supply line on occasions of frequent on/off operations. (Measure Guideline: Transitioning to a Tankless Water Heater, DOE, Sept. 2012.)

Cascade up to 32 units and common vent up to 12 units

With Navien cascading technology, when a unit gets up to 80% capacity the next unit will turn on to help meet requirements. This demand ratio will continue until all 32 units are generating hot water. The Navien cascading system also balances out the workload of each unit for longer life. Building penetrations are reduced with Navien's common venting feature.



NPE-A2 Advanced



NPE-S2 Standard



NPE-A2 combination heating and DHW system

The optional H2Air® kit utilizes the NPE-A2 pump to circulate the hot water for the hydronic air handler, no need to purchase an additional circulator. Designed for retrofit and new construction, the kit includes an add-on controller to integrate space heating and DHW between any NPE-A2 series tankless water heater and a hydronic air handler.

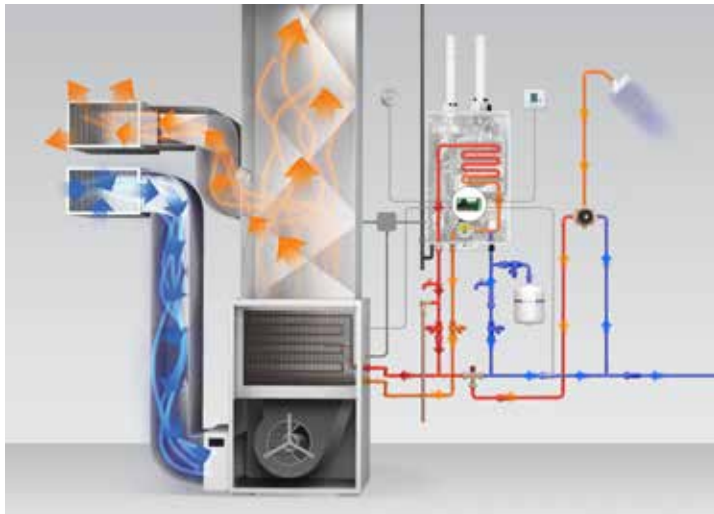

Multi-line control with built-in intuitive software

An all-new backlit EZNav™ control with setup wizard software, uses simple text and icons to make startup, operation status and troubleshooting faster and easier.



2" PVC venting up to 75 feet. Low exhaust gas temperatures allow use of PVC (including schedule 40 PVC), CPVC, polypropylene (rigid and flexible) and stainless steel venting saving time and costs.

Vent Installation Detector (VID) for added safety.



Dual Venturi for field gas conversions.

Dual Venturi system creates better combustion control and turndown ratio. Field gas convertibility is easy with orifice conversion kits for NG high altitude (5,400–10,100 ft.) and LP (up to 10,100 ft.) included with NPE-2 tankless water heaters. 



Dual stainless steel heat exchangers for added durability.



1/2" gas pipe capability up to 24' (subject to local codes). Cuts installation time, no need to install new gas lines for retrofit applications.

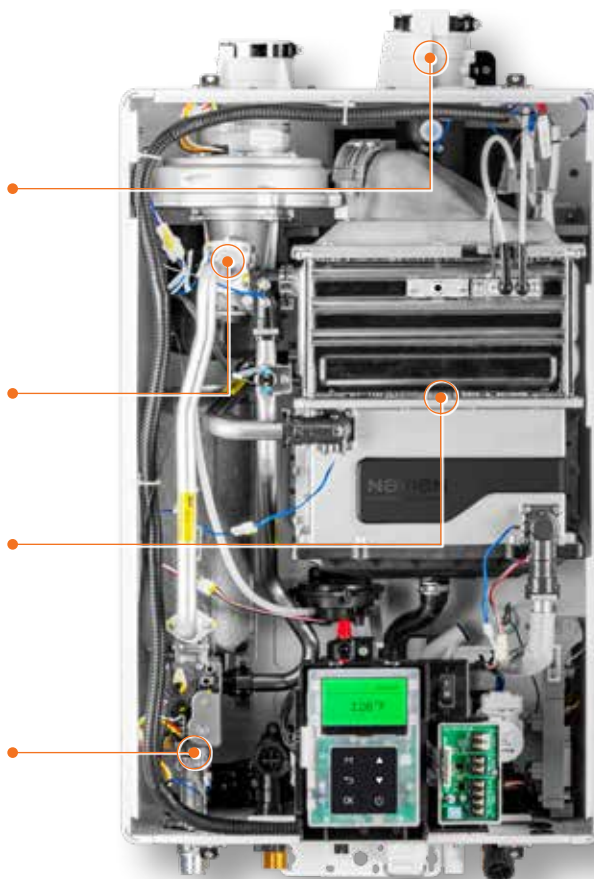

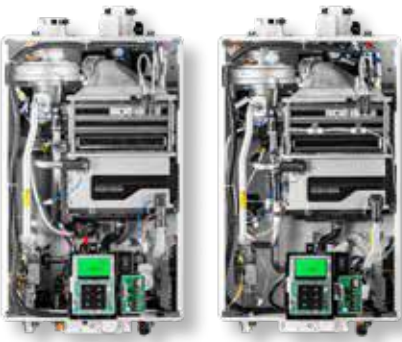

NPE-Advanced

NPE-Standard

NPE-A2 Advanced NPE-S2 Standard

NAVIEN PREMIUM EFFICIENCY CONDENSING TANKLESS WATER HEATERS



Optional Wi-Fi remote control system

This add-on accessory will enable customers with smartphones and tablets to control temperatures remotely, access usage data and receive diagnostic notifications on all Navien NPE-A2 and NPE-S2 tankless water heaters.



NPE-2 Series water heater accessories



NaviLink
Wi-Fi control
PBCM-AS-001
Expansion cable
GXXX001659



NaviLink
Wi-Fi control
PBCM-AS-002



H2Air
kit
AHU optimizer
PNBD-000001



NaviCirc
recirculation valve
NaviCirc™
PFFW-SXX-001
NaviCirc™ kit
Includes 1/2" hoses and adapters
30022965A



PeakFlowS
standard scale
prevention system
GPWC1101AC001



Optional NPE-2 hot water activation system*

At the push of a button, the HotButton® hot water system activates internal recirculation pump and gas fired burner to heat water in the supply lines to provide hot water only when needed. NPE-2 comes with a built-in HotButton controller.



Optional NPE-2 recirculation valve*

Designed for recirculation of domestic hot water in applications where a dedicated return line is not available.

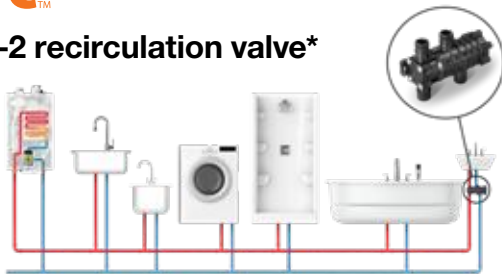

*External pump necessary for NPE-S2 not included.

NPE-2 Series water heater accessories



HotButton[®]
components
Wall plate
 GXXX001427
Push button
 GXXX001426



Remote controller NPE-2 Series
 30022717B



Plumb easy valve set (V2) 3/4"
with relief valve
 GXXX002139



2" and 3" wall flange and vent terminator kit
2" kit
 30010747A
3" kit
 30003873B



NPE-A/NPE-A2 plumb easy 3-valve set (V2)
 GXXX002140



Common vent collar kit
 30014367B
 Includes cascade cable (GXXX000546), common vent collar damper and VID jumper cable.

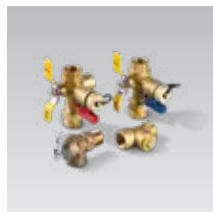

Plumb easy valve 3/4" with relief valve
 (Designed to work with pipe cover)
 30012581A



Vent cap NPE-2 Series
 30025801A



Residential neutralizer (V2)
 1 unit
 GXXX002212
Residential replacement media
 GXXX001323



Pipe cover NPE-2 Series
 30025812A
Use with isolation valves
 30012581A

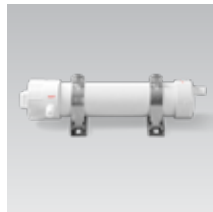

Light commercial neutralizer
 GXXX001324
Light commercial replacement media
 GXXX001328



Ready-Link[®]
communication cable
 GXXX000546



Commercial neutralizer
 GXXX001325
Commercial replacement media
 GXXX001329

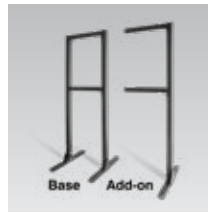

Ready-Link[®]
rack
Base (V3)
 GFFMKDIZUS-005
Add-on (V3)
 GFFMKDIZUS-006

NPE-2 NAVIEN READY-LINK MODULAR MANIFOLD MOUNTING SYSTEM



Now manifold mounting on a wall or rack is as simple as 1-2-3-4

- Simply no waiting for custom racks
- Simply easy to transport, assemble and install
- Simply more profitable
- Simply visit your local Navien wholesaler and pick up everything you need for your installation today



Each kit includes the following items in varying quantities based on the kit selected:

- 3/4" x 3/4" adapter
- 3/4" NPT ball valve
- 1-1/2" gas union
- 2" copper end cap
- 2" copper coupling
- 2-1/8" strut clamp
- Hardware kit
- 3/4" service valves with PRV
- 1-5/8" x 18" strut channel (14ga)
- 3/4" x 24" SS corrugated flex connector
- 3/4" x 30" gas flex connector
- 3/4" x 18" SS corrugated flex connector
- 1-1/2" FPT galvanized iron end cap
- 1-7/8" OD strut clamp

1 Pick your Navien unit, NPE-A2 or NPE-S2



2 Pick your location, wall or rack

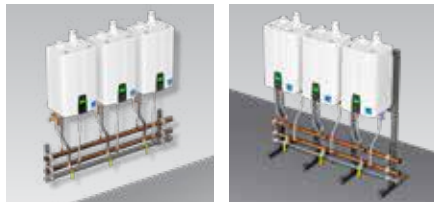



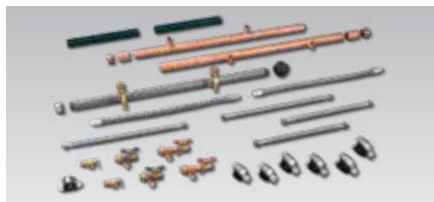



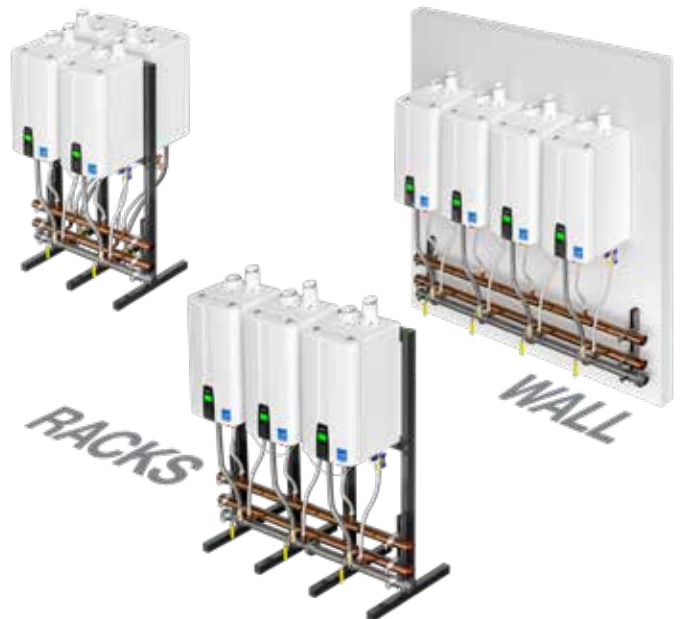







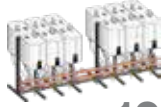













3 Pick your matching manifold kit(s)



4 Pick your intake/exhaust venting configuration



Ready-Link[®] manifold configurations

2 Unit Side-by-Side Manifold  2	4 and 3 Unit Side-by-Side Manifold  7	3 and 3 Unit Side-by-Side Manifold (bank 1) + 3 and 3 Unit Side-by-Side Manifold (bank 2)  12
2 Unit Back-to-Back Manifold  2	4 and 4 Unit Back-to-Back Manifold  7	4 and 2 Unit Back-to-Back Manifold (bank 1) + 4 and 2 Unit Back-to-Back Manifold (bank 2)  12
3 Unit Side-by-Side Manifold  3	4 and 4 Unit Side-by-Side Manifold  8	4 and 4 Unit Side-by-Side Manifold (bank 1) + 3 and 2 Unit Side-by-Side Manifold (bank 2)  13
4 Unit Back-to-Back Manifold  3	4 and 4 Unit Back-to-Back Manifold  8	4 and 4 Unit Back-to-Back Manifold (bank 1) + 4 and 2 Unit Back-to-Back Manifold (bank 2)  13
4 Unit Side-by-Side Manifold  4	3 and 2 Unit Side-by-Side Manifold (bank 1) + 4 Unit Side-by-Side Manifold (bank 2)  9	4 and 3 Unit Side-by-Side Manifold (bank 1) + 4 and 3 Unit Side-by-Side Manifold (bank 2)  14
4 Unit Back-to-Back Manifold  4	4 and 2 Unit Back-to-Back Manifold (bank 1) + 3 Unit Side-by-Side Manifold (bank 2)  9	4 and 4 Unit Back-to-Back Manifold (bank 1) + 4 and 2 Unit Back-to-Back Manifold (bank 2)  14
3 and 2 Unit Side-by-Side Manifold  5	3 and 2 Unit Side-by-Side Manifold (bank 1) + 3 and 2 Unit Side-by-Side Manifold (bank 2)  10	4 and 4 Unit Side-by-Side Manifold (bank 1) + 4 and 3 Unit Side-by-Side Manifold (bank 2)  15
4 and 2 Unit Back-to-Back Manifold  5	4 and 4 Unit Back-to-Back Manifold (bank 1) + 2 Unit Back-to-Back Manifold (bank 2)  10	4 and 4 Unit Back-to-Back Manifold (bank 1) + 4 and 4 Unit Back-to-Back Manifold (bank 2)  15
4 and 2 Unit Side-by-Side Manifold  6	4 and 3 Unit Side-by-Side Manifold (bank 1) + 4 Unit Side-by-Side Manifold (bank 2)  11	4 and 4 Unit Side-by-Side Manifold (bank 1) + 4 and 4 Unit Side-by-Side Manifold (bank 2)  16
4 and 2 Unit Back-to-Back Manifold  6	4 and 4 unit Back-to-Back Manifold (bank 1) + 4 Unit Back-to-Back Manifold (bank 2)  11	4 and 4 Unit Back-to-Back Manifold (bank 1) + 4 and 4 Unit Back-to-Back Manifold (bank 2)  16

NOTE: When adding additional manifolds, field adjustment of the main piping may be necessary in order to properly connect the provided flex connectors to the water heaters. Other configurations are possible. Rack not required for wall mount. Ready-Link[®] Rack Base and Add-on Components sold separately.



NPE-Advanced

NPE-Standard

NPE-A2 Advanced NPE-S2 Standard

NAVIEN PREMIUM EFFICIENCY CONDENSING TANKLESS WATER HEATERS

Dimensions

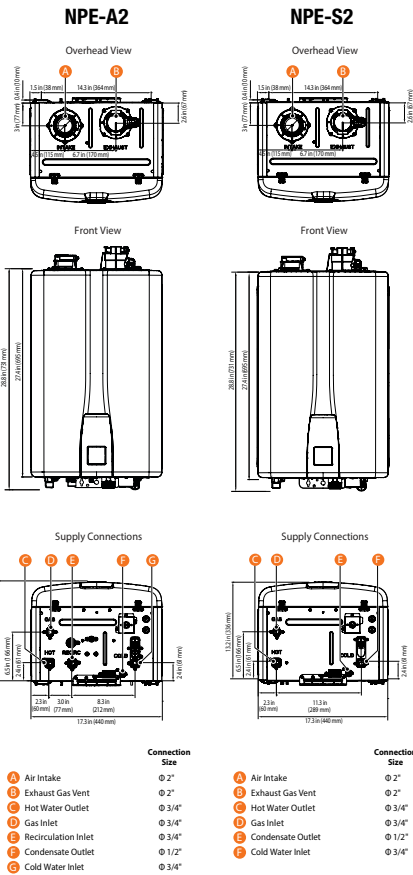

Specifications

Item	Model							
	NPE-150S2	NPE-180A2	NPE-180S2	NPE-210A2	NPE-210S2	NPE-240A2	NPE-240S2	
Heat capacity (input)	Natural gas 18,000–120,000 BTU/h	10,000–150,000 BTU/h		12,000–180,000 BTU/h		13,300–199,900 BTU/h		
Energy factor	UEF (for NG & LP) 0.93	0.95	0.96	0.95	0.96	0.95	0.96	
Flow rate (DHW)	35°F (19°C) temp rise	6.8 GPM (26 L/m)	8.4 GPM (32 L/m)	10.1 GPM (38 L/m)		11.2 GPM (42 L/m)		
	45°F (25°C) temp rise	5.3 GPM (20 L/m)	6.5 GPM (25 L/m)	7.8 GPM (30 L/m)		8.7 GPM (33 L/m)		
	67°F (36°C) temp rise	3.4 GPM (13 L/m)	4.3 GPM (16 L/m)	4.4 GPM (17 L/m)	5.1 GPM (19 L/m)	5.3 GPM (20 L/m)	5.6 GPM (21 L/m)	5.8 GPM (22 L/m)
Dimensions	17.3" (W) x 27.4" (H) x 13.2" (D)							
Weight	62 lbs (28 kg)	73 lbs (33 kg)	68 lbs (31 kg)	77 lbs (35 kg)	73 lbs (33 kg)	77 lbs (35 kg)	73 lbs (33 kg)	
Installation type	Indoor or outdoor wall-hung							
Venting type	Forced draft direct-vent							
Ignition	Electronic ignition							
Water pressure	15–150 PSI							
Natural gas supply pressure (from source)	3.5" WC–10.5" WC							
Propane gas supply pressure (from source)	8" WC–13" WC							
Natural gas manifold pressure (min-max)	-0.04" WC– -0.40" WC	-0.03" WC– -0.55" WC		-0.03" WC– -0.76" WC		-0.03" WC– -0.96" WC		
Propane gas manifold pressure (min-max)	-0.03" WC– -0.40" WC	-0.02" WC– -0.55" WC		-0.02" WC– -0.76" WC		-0.02" WC– -0.96" WC		
Minimum flow rate	0.5 GPM (1.9 L/m), < 0.01 GPM (0.04 L/m) option for "A2" models*							
Connection sizes	Cold water inlet	3/4" NPT						
	How water outlet	3/4" NPT						
	Gas inlet	3/4" NPT						
Power supply	Main supply	120V AC, 60 Hz						
	Maximum power consumption	200 W (max 2 A), 350 W (max 4 A) with external pump connected						
Materials	Casing	Cold rolled carbon steel						
	Heat exchangers	Primary heat exchanger: stainless steel Secondary heat exchanger: stainless steel						
Venting	Exhaust	2" or 3" PVC, CPVC, approved polypropylene and stainless steel 2" or 3" special gas vent type BH (Class II, A/B/C)						
	Intake	2" or 3" PVC, CPVC, approved polypropylene and stainless steel 2" or 3" special gas vent type BH (Class II, A/B/C)						
	Vent clearances	0" to combustibles						
High elevations	10,100 feet for both NG or LP gas. Please refer to Installation Manual for additional details and instructions.							
Safety devices	Flame rod, APS, ignition operation detector, water temperature high limit switch, exhaust temperature high limit sensor, power surge fuse, burner high limit fuse, Vent Installation Detector (VID)							

*Available for NPE-A2 models configured in an optional ComfortFlow® recirculation mode. Energy consumption will increase when the system is configured for recirculation.

Navien reserves the right to change specifications at any time without prior notice. Please refer to www.Navieninc.com to verify you have the most current information.

Navien certification summary (Note: all NPE-2 models are field convertible from NG to LP gas)

Model	Product Approvals					Efficiency Ratings*			Annual Energy Consumption* (Residential)		
	CSA	NSF (Standard 5)	Low Lead (<0.25%)	SCAQMD 1146.2 (NOx, <20ppm)	AHRI Number	Energy Star	Uniform Energy Factor (UEF)	Max GPM (L/m) (67°F Rise)	Natural Gas (Therms/Year)	Propane (Gallons/Year)	Estimated Operating Cost**
NPE-180A2-NG	Yes	Yes	Yes	Yes	206368357	Yes	0.95	4.3 (16)	179		\$195
NPE-180A2-LP	Yes	Yes	Yes	Yes	206368357	Yes	0.95	4.3 (16)		196	\$472
NPE-210A2-NG	Yes	Yes	Yes	Yes	206368358	Yes	0.95	5.1 (19)	179		\$195
NPE-210A2-LP	Yes	Yes	Yes	Yes	206368358	Yes	0.95	5.1 (19)		196	\$472
NPE-240A2-NG	Yes	Yes	Yes	Yes	206368359	Yes	0.95	5.6 (21)	179		\$195
NPE-240A2-LP	Yes	Yes	Yes	Yes	206368359	Yes	0.95	5.6 (21)		196	\$472
NPE-150S2-NG	Yes	Yes	Yes	Yes	206423843	Yes	0.93	3.4 (13)	120		\$131
NPE-150S2-LP	Yes	Yes	Yes	Yes	206423843	Yes	0.93	3.4 (13)		131	\$316
NPE-180S2-NG	Yes	Yes	Yes	Yes	206368360	Yes	0.96	4.4 (17)	177		\$193
NPE-180S2-LP	Yes	Yes	Yes	Yes	206368360	Yes	0.96	4.4 (17)		194	\$468
NPE-210S2-NG	Yes	Yes	Yes	Yes	206368361	Yes	0.96	5.3 (20)	177		\$193
NPE-210S2-LP	Yes	Yes	Yes	Yes	206368361	Yes	0.96	5.3 (20)		194	\$468
NPE-240S2-NG	Yes	Yes	Yes	Yes	206368362	Yes	0.96	5.8 (22)	177		\$193
NPE-240S2-LP	Yes	Yes	Yes	Yes	206368362	Yes	0.96	5.8 (22)		194	\$468

*Based on U.S. Department of Energy (DOE) test procedures.

**Based on a national average natural gas cost of \$1.09/therm, propane cost of \$2.41/gallon.



Temperature rise (maximum output)

Temp Rise °F (°C)	NPE-150S2 GPM (L/m)	NPE-180A2/S2 GPM (L/m)	NPE-210A2/S2 GPM (L/m)	NPE-240A2/S2 GPM (L/m)
35 (19)	6.8 (26)	8.4 (32)	10.1 (38)	11.2 (42)
40 (22)	5.9 (22)	7.4 (28)	8.8 (33)	9.8 (37)
45 (25)	5.3 (20)	6.5 (25)	7.8 (30)	8.7 (33)
50 (28)	4.8 (18)	5.9 (22)	7.1 (27)	7.8 (30)
55 (31)	4.3 (16)	5.3 (20)	6.4 (24)	7.1 (27)
60 (33)	4.0 (15)	4.9 (19)	5.9 (22)	6.5 (25)
65 (36)	3.7 (14)	4.5 (17)	5.4 (20)	6.0 (23)
70 (39)	3.4 (13)	4.2 (16)	5.0 (19)	5.6 (21)
75 (43)	3.2 (12)	3.9 (15)	4.7 (18)	5.2 (20)
80 (44)	3.0 (11)	3.7 (14)	4.4 (17)	4.9 (19)
85 (47)	2.8 (11)	3.5 (13)	4.2 (16)	4.6 (17)
90 (50)	2.6 (10)	3.3 (12)	3.9 (15)	4.4 (17)
100 (56)	2.4 (9)	2.9 (11)	3.5 (13)	3.9 (15)
110 (61)	2.2 (8)	2.7 (10)	3.2 (12)	3.6 (14)
120 (67)	2.0 (8)	2.5 (9)	2.9 (11)	3.3 (12)
130 (72)	1.8 (7)	2.3 (9)	2.7 (10)	3.0 (11)
140 (78)	1.7 (6)	2.1 (8)	2.5 (9)	2.8 (11)

DHW capacity

Models	Natural Gas (BTU/h)	Propane Gas (BTU/h)
NPE-150S2	18,000–120,000	18,000–120,000
NPE-180A2/S2	10,000–150,000	10,000–150,000
NPE-210A2/S2	12,000–180,000	12,000–180,000
NPE-240A2/S2	13,300–199,900	13,300–199,900

Operating cost

Navien tankless	179 therms	\$195*
Other tankless	209 therms	\$228*
Standard tank	269 therms	\$293*

*Based on Energy Guide cost estimates using \$1.09 per therm of natural gas. Cost is in US dollars.

Warranty

Application		Labor	Parts	Heat Exchanger
Residential	Standard or controlled recirculation ²	1 year	5 years	15 years
	Uncontrolled recirculation ³	1 year	3 years	5 years
Commercial or Combi ¹	Standard or controlled recirculation ²	1 year	5 years	8 years
	Uncontrolled recirculation ³	1 year	3 years	3 years

¹ Combi refers to a combination potable water and space heating application. Water heaters cannot be used in space heating only applications.

² Controlled-Recirculation: Recirculation through the water heater is controlled by either the water heater or an external aquastat.

³ Uncontrolled-Recirculation: External pumps configured to circulate continuously through the water heater are subject to the uncontrolled recirculation warranty terms. An aquastat is the minimum pump control requirement for DHW or storage tank recirculation in order to maintain the full controlled recirculation warranty.

For complete details please refer to the full warranty at Navieninc.com.

U.S. Green Building Council LEED points*

Water Heater	Location	Recirculation
1.5 Points	2 Points	3 Points

Lower HERS Home Index Score*

*Please consult your Energy/LEED consultant.



NPN NAVIEN PREMIUM NON-CONDENSING TANKLESS WATER HEATERS

No one has put more ingenuity into non-condensing tankless than Navien

The NPN Series brings you endless hot water, innovations and energy savings

Navien's NPN series is the first and only non-condensing tankless water heater series that offers a durable stainless-steel heat exchanger and a patented stainless steel burner design, all with Navien's dedication to advanced engineering, elegant design and exceptional product quality, support and strong warranties.

- Choice of universal indoor/outdoor or outdoor only operation
- For residential/commercial use and cascade capable
- NaviVent™ concentric 3" x 5" venting
- Units available in either Natural Gas (NG) or Liquid Propane (LP) gas

NAVITECH™
STAINLESS STEEL
HX AND BURNER

PREMIUM
INTEGRATED
CONTROLS

0.81 UEF

98°-140°
TEMP RANGE

9.5 GPM
@ 35° TEMP RISE

CASCADE UP TO
2 UNITS



NPN-Universal
indoor version



NPN-Universal with
vent cap for outdoor use



NPN-Exterior
outdoor only



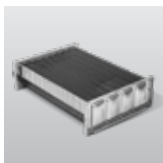

Exclusive NaviTech™ stainless steel heat exchanger. NPN is the first non-condensing unit with a stainless steel heat exchanger.

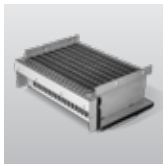

Patented NaviTech™ stainless steel burner with precision control flame technology for eco-friendly low NOx emissions comparable to condensing burners.



Circuitry with built-in recirculation control and software. No need to add separate controller saving installation time and money.



Built-in Water Adjustment Valve (WAV) and mixing valve controls flow to maintain setpoint and stabilizes temperature during flow changes.



NPN Series integrated control panel allows you to adjust water temperature, operation status and troubleshooting.

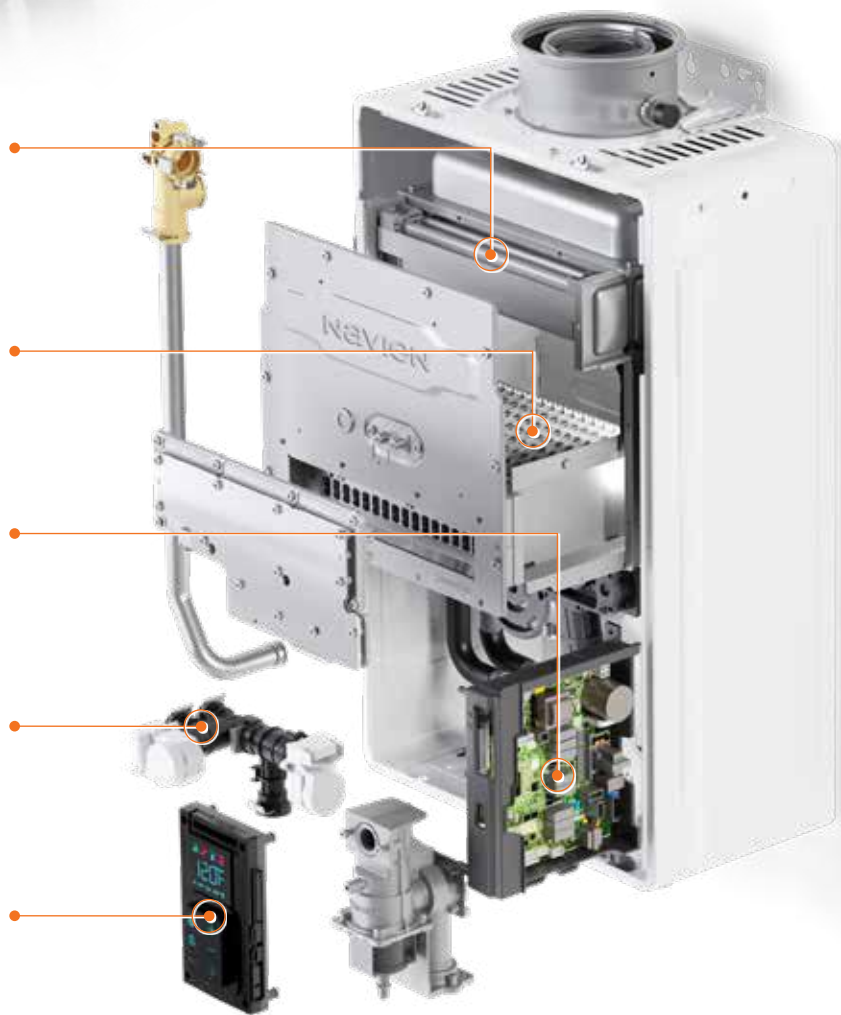



NPN-Universal
indoor version

NPN-Universal
with vent cap
for outdoor use

NPN-Exterior
outdoor only

NPN-Universal NPN-Exterior

NAVIEN PREMIUM
NON-CONDENSING
TANKLESS WATER HEATERS

NPN water heater accessories



NaviLink
Wi-Fi control
PBCM-AS-001
Expansion cable
GXXX001659



PeakFlow-S
standard scale
prevention system
GPWC1101AC001



Ready-Link
communication cable
GXXX000546

External pump wire
GXXX001319



NaviLink
Wi-Fi control
PBCM-AS-002



Remote controller
Optional for
NPN-U models
30022717B



Outdoor vent cap kit
(NPN-U only)
30023991A



H2Air
kit
AHU optimizer
PNBD-000001

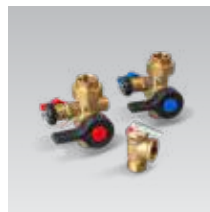

Plumb easy valve set (V2) 3/4"
with relief valve
GXXX002139



Pipe cover NPN Series
30024017A



HotButton
control kit
PZZZ-00046
Wall plate
GXXX001427
Push button
GXXX001426



Ready-Link
rack
Base (V3)
GFFMKDIZUS-005
Add-on (V3)
GFFMKDIZUS-006



Recess box
NPN-E only
lock not included
30023550A



3" x 5" concentric venting accessories

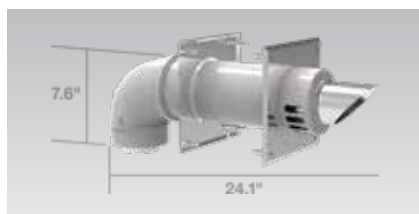

Sidewall standard termination kit
11.5" (292mm)
GXXX001891

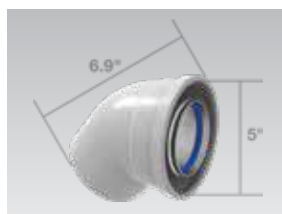

Elbow
80-125 mm 45°
GXXX001894

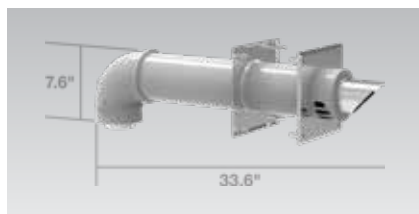

Sidewall long termination kit
21" (533mm)
GXXX001892



Elbow
80-125 mm 90°
GXXX001895

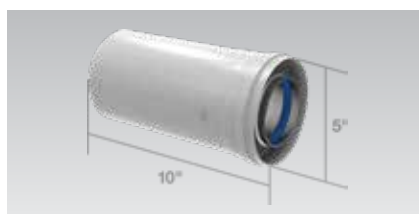

Vent pipe extension
10" (254mm)
GXXX001896

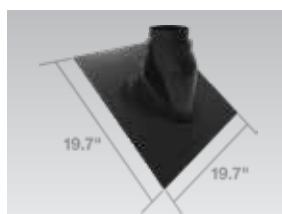

Adjustable roof flashing
GXXX001901

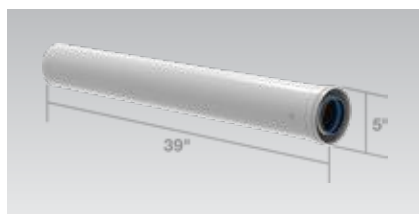

Vent pipe extension
39" (991mm)
GXXX001897



Concentric roof termination
13" (330mm) – GXXX001893



Metal wall strap
GXXX001902

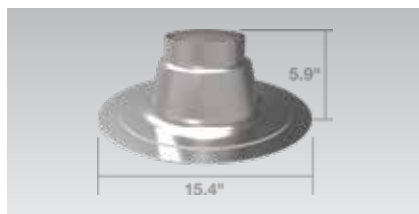

Flat roof flashing
GXXX001900



Condensate trap kit
GXXX001952



NPN-Universal
indoor version

NPN-Universal
with vent cap
for outdoor use

NPN-Exterior
outdoor only

NPN-Universal NPN-Exterior

NAVIEN PREMIUM NON-CONDENSING TANKLESS WATER HEATERS

Dimensions

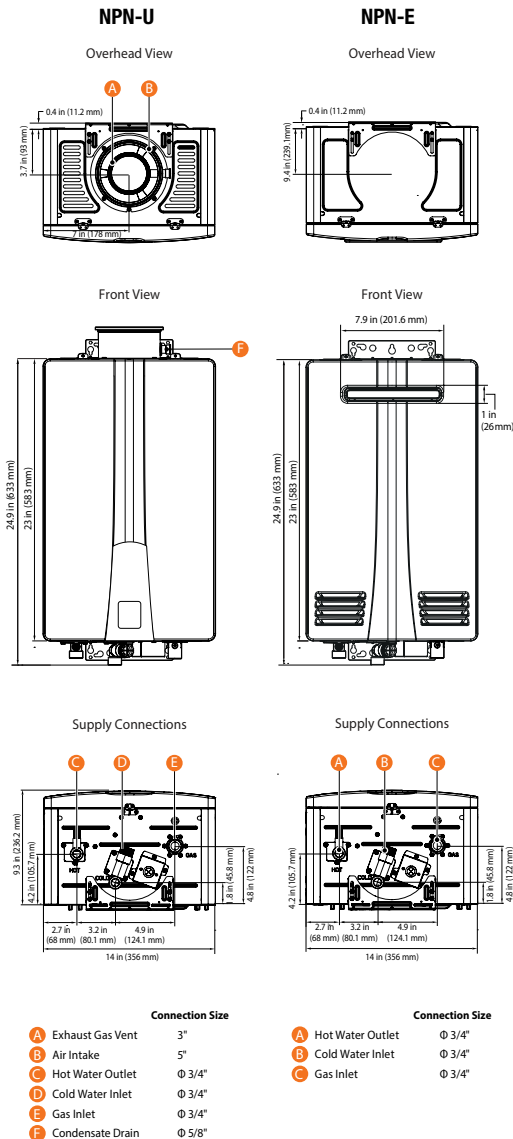

Specifications

Item	NPN-Universal Model			NPN-Exterior Model		
	NPN-160U	NPN-180U	NPN-199U	NPN-160E	NPN-180E	NPN-199E
Heat capacity (input) natural gas/propane gas	10,700–160,000 (BTU/h)	10,700–180,000 (BTU/h)	10,700–199,900 (BTU/h)	10,700–160,000 (BTU/h)	10,700–180,000 (BTU/h)	10,700–199,900 (BTU/h)
Efficiency rating for NG & LP	0.81 UEF					
Flow rate (DHW)	35°F (18°C) temp rise	7.6 GPM (29 L/m)	8.5 GPM (32 L/m)	9.5 GPM (36 L/m)	7.6 GPM (29 L/m)	8.5 GPM (32 L/m)
	45°F (23°C) temp rise	5.9 GPM (22 L/m)	6.6 GPM (25 L/m)	7.4 GPM (28 L/m)	5.9 GPM (22 L/m)	6.6 GPM (25 L/m)
	67°F (36°C) temp rise	4.0 GPM (15 L/m)	4.6 GPM (17 L/m)	5.1 GPM (19 L/m)	4.0 GPM (15 L/m)	4.6 GPM (17 L/m)
Dimensions	14.0" W x 23.0" H x 9.3" D					
Weight	55 lbs (25 kg)	60 lbs (27 kg)	60 lbs (27 kg)	55 lbs (25 kg)	60 lbs (27 kg)	60 lbs (27 kg)
Installation type	Indoor wall-hung (vent kit option for outdoor)					
Venting type	Forced draft direct vent (indoor only)					
Ignition type	Electronic ignition					
Water pressure	15–150 PSI					
Natural gas supply pressure (from source)	3.5" WC–10.5" WC					
Propane gas supply pressure (from source)	8" WC–13" WC					
Natural gas manifold pressure (min-max)	2.83" WC, 0.70" WC	2.25" WC, 0.53" WC	2.81" WC, 0.53" WC	3.23" WC, 0.69" WC	2.38" WC, 0.53" WC	2.99" WC, 0.52" WC
Propane gas manifold pressure (min-max)	5.93" WC, 1.38" WC	5.28" WC, 1.31" WC	6.55" WC, 1.31" WC	6.34" WC, 1.35" WC	5.39" WC, 1.28" WC	6.61" WC, 1.28" WC
Minimum flow rate	0.5 GPM (1.9L/m)					
Connection sizes	3/4" NPT cold water inlet 3/4" NPT hot water outlet 3/4" NPT gas inlet					
Power supply	Main supply	120V AC, 60 Hz				
	Normal	90 W	88 W	120 W	90 W	88 W
	Standby	4 W				
	Anti-frost	114 W				
	External pump	< 150 W, 1.5 A				
Materials	Fuse	5.0 A				
	Casing	Cold rolled carbon steel				
Heat exchanger	Stainless steel					
Safety devices	Flame rod, APS, ignition operation detector, water temperature high limit switch, power surge fuse					

Navien reserves the right to change specifications at any time without prior notice.

Please refer to www.NavienInc.com to verify you have the most current information.

Navien certification summary

Model	Product Approvals					Efficiency Ratings*	
	CSA	NSF (Standard 5)	Low Lead (<0.25%)	Ultra Low NOx	AHRI Number	Uniform Energy Factor (UEF)	Max GPM (35°F Rise)
NPN-160U-NG	Yes	Yes	Yes	Yes	205042074	0.81	7.6
NPN-160U-LP	Yes	Yes	Yes	Yes	205042075	0.81	7.6
NPN-180U-NG	Yes	Yes	Yes	Yes	204524353	0.81	8.5
NPN-180U-LP	Yes	Yes	Yes	Yes	204524354	0.81	8.5
NPN-199U-NG	Yes	Yes	Yes	Yes	204524349	0.81	9.5
NPN-199U-LP	Yes	Yes	Yes	Yes	204524350	0.81	9.5
NPN-160E-NG	Yes	Yes	Yes	Yes	205042076	0.81	7.6
NPN-160E-LP	Yes	Yes	Yes	Yes	205042077	0.81	7.6
NPN-180E-NG	Yes	Yes	Yes	Yes	204524355	0.81	8.5
NPN-180E-LP	Yes	Yes	Yes	Yes	204524356	0.81	8.5
NPN-199E-NG	Yes	Yes	Yes	Yes	204524351	0.81	9.5
NPN-199E-LP	Yes	Yes	Yes	Yes	204524352	0.81	9.5

*Based on U.S. Department of Energy (DOE) test procedures.



Temperature rise (maximum output)

Temp Rise °F (°C)	NPN-160 U/E GPM (L/m)	NPN-180 U/E GPM (L/m)	NPN-199 U/E GPM (L/m)
30 (17)	8.9 (34)	10.0 (38)	11.1 (42)
35 (19)	7.6 (29)	8.5 (32)	9.5 (36)
40 (22)	6.6 (25)	7.5 (28)	8.3 (31)
45 (25)	5.9 (22)	6.6 (25)	7.4 (28)
50 (28)	5.3 (20)	6.0 (23)	6.6 (25)
55 (31)	4.8 (18)	5.4 (20)	6.0 (23)
60 (33)	4.4 (17)	5.0 (19)	5.5 (21)
65 (36)	4.1 (16)	4.6 (17)	5.1 (19)
70 (39)	3.8 (14)	4.3 (16)	4.7 (18)
75 (43)	3.5 (13)	4.0 (15)	4.4 (17)
80 (44)	3.3 (12)	3.7 (14)	4.1 (16)
85 (47)	3.1 (12)	3.5 (13)	3.9 (15)
90 (50)	3.0 (11)	3.3 (12)	3.7 (14)
100 (56)*	2.7 (10)	3.0 (11)	3.3 (12)

*Max temperature setting is 140°F (60°C).

DHW capacity

Models	Natural Gas/Propane Gas (BTU/h)
NPN-160 U/E series	10,700–160,000
NPN-180 U/E series	10,700–180,000
NPN-199 U/E series	10,700–199,900

Warranty

Application	Labor	Parts	Heat Exchanger	
Residential	Standard	1 year	5 years	15 years
	Uncontrolled Recirculation ²	1 year	3 years	5 years
Commercial or Combi ¹	Standard	1 year	5 years	5 years
	Uncontrolled Recirculation ²	1 year	3 years	3 years

¹ Combi refers to a combination potable water and space heating application. Water heaters cannot be used in space heating only applications.

² Uncontrolled-Recirculation: External pumps configured to circulate continuously through the water heater are subject to the uncontrolled recirculation warranty terms. An aquastat is the minimum pump control requirement for DHW or storage tank recirculation in order to maintain the full controlled recirculation warranty.

For complete details please refer to the full warranty at NavienInc.com.

NCB-H NAVIEN HIGH CAPACITY WATER TUBE CONDENSING COMBI-BOILERS

Aim high with Navien...
High efficiency, High output,
all in one compact combi

- **Highest** DHW maximum BTUs in residential combi-boilers... up to 210,000 per hour
- **Highest** DHW flow rate @ 70°F rise... up to 5.4 GPM
- **Highest** number of BTU sizes for the North American residential combi-boiler market
- **Highest** residential combi DHW TDR...15:1
- **Highest** residential combi heating TDR...up to 11:1*
- **Highest** number of built-in zone controls for valves or pumps... up to three
- **Highest** full lineup with 2" venting lengths... up to 65 feet
- **Highest** number of cascade capable units with NPE-2 tankless water heaters... up to 15
- **High altitude certification**... up to 10,100 feet (NG or LP)
- **Lowest minimum fire BTU** for residential combi-boilers... as low as 10,700

*Based on NCB-250/150H.



NCB-H Series

New built-in DHW module now with higher performance. Navien's NCB-H can generate enough hot water to run up to 3 showers and a dishwasher at the same time.

DHW module is easily accessible behind circuitry/control panel.

Integrated boiler pump.

Flow adjustment valve.

DHW stainless steel heat exchanger. Up to 5.4 GPM @ 70°F temp. rise. The highest flow rate in the industry.

Mixing valve.

3-way valve.



Vent Installation Detection (VID).

2" PVC venting up to 65 feet including economical schedule 40 PVC.

Dual Venturi and field gas convertibility. Dual Venturi system creates better combustion control and turndown ratio. Field gas convertibility is easy with orifice conversion kits for NG high altitude (5,400–10,100 ft.) and LP (up to 10,100 ft.) included with NCB-H series combi-boilers.



Advanced user interface with Setup Wizard. Navien's new backlit control panel is simple and intuitive to use with its plain text display and an innovative click wheel that improves usability for all information input.

Built-in control for 3-zone pumps or 3-zone valves. Connections are powered, not just dry contact relays. The supplied power by PCB board is 120VAC for zone pumps and 24VAC for zone valves.



High efficiency stainless steel burner. Navien designed and built, fully modulating metal fiber premix burner system.

Dual stainless steel heat exchangers for heating. Stainless steel heat exchangers offer durability and added condensing performance.

Separate SS flat plate heat exchanger for DHW. DHW heat exchanger delivers up to 5.4 GPM at 70°F temperature rise, the highest flow rate in the industry.



NCB-H

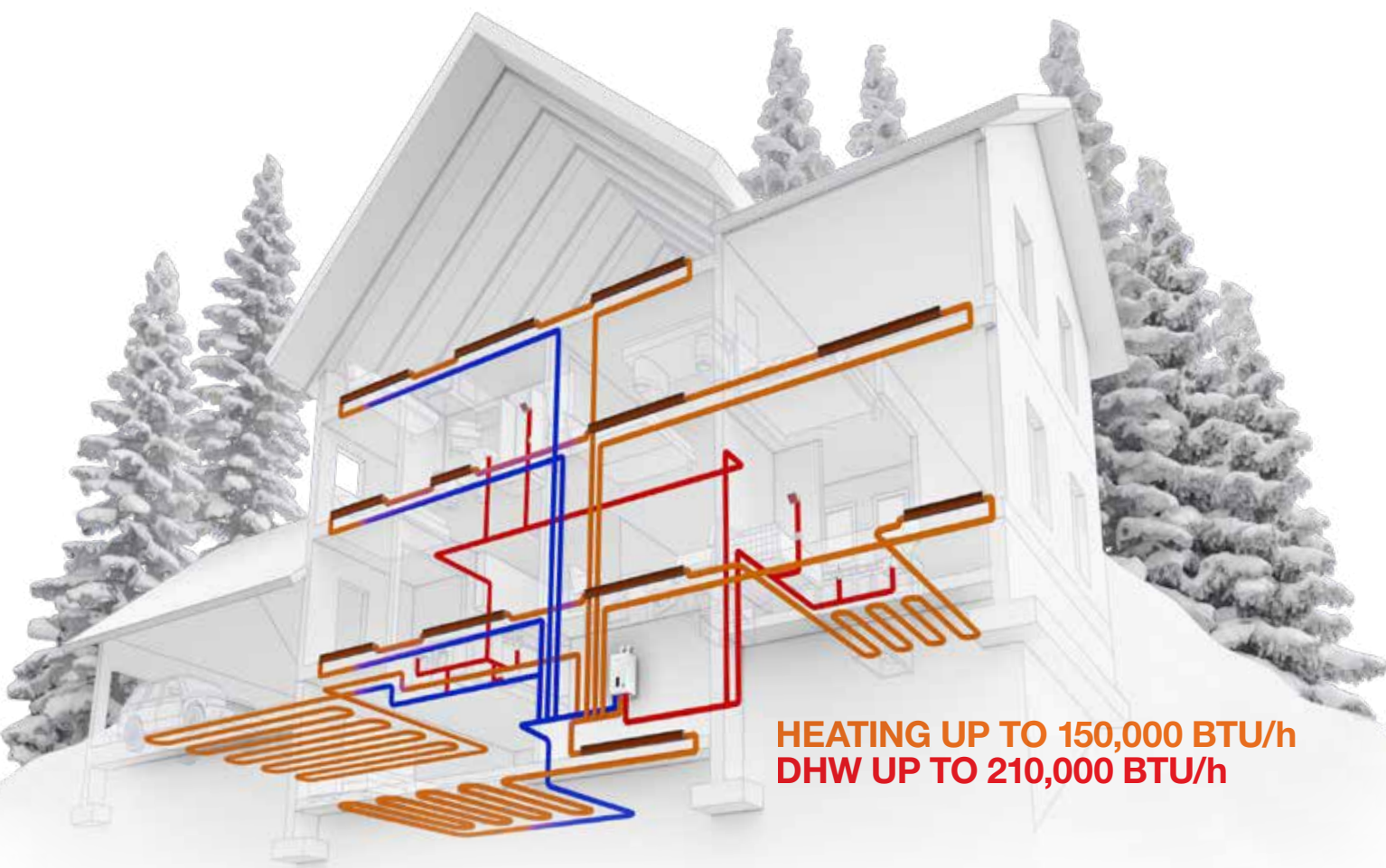

HEATING UP TO 150,000 BTU/h
DHW UP TO 210,000 BTU/h





NCB-H

NCB-H Series

NAVIEN HIGH CAPACITY WATER TUBE CONDENSING COMBI-BOILERS



Compare these advantages and see why NCB-H is the right fit for any size family



Dual inputs of up to 150,000 BTU/h for heating and 210,000 BTU/h for DHW

Satisfies all the space heating and domestic hot water requirements of most typical large homes.



2" PVC venting and 1/2" gas pipe capability

Save time and effort in retrofit application with 2" PVC venting up to 65' or up to 150' with 3" venting. 1/2" gas lines for up to 24' also speeds up installations.

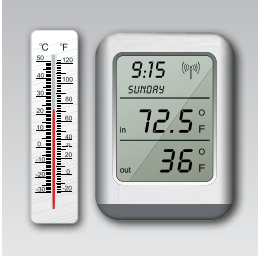

TDR 15:1 for DHW and up to 11:1 for heating

The sophisticated gas flow control system provides a high turndown ratio, reducing energy waste and excessive boiler cycling and enhances temperature control for DHW.



Easy access to DHW module and valves

All components of DHW module including water feed valve, flow adjustment valve, mixing valve and cartridge-style 3-way valve are right behind circuit board for easy serviceability.



Space saving and lightweight design

Navien's sleek wall-hung combi-boilers occupy 80% less space than traditional floor standing boilers and tank water heaters.



Expanded DHW capability

For increased domestic hot water flow demand, the NCB-H can be cascaded with up to 15 NPE-2 units.



Quiet running

Navien products are engineered to operate at comfortably low noise levels.



5 NCB-H models for any size home

Available in NCB-190/060H, NCB-190/080H, NCB-240/110H, NCB-240/130H, NCB-250/150H, giving you multiple options to match any size house, apartment, condo...big or small.

NCB-H Series combi-boiler accessories



NaviLink
Wi-Fi control
 PBCM-AS-001
Expansion cable
 GXXX001659



NaviLink
Wi-Fi control
 PBCM-AS-002



NaviCirc
recirculation valve
NaviCirc™
 PFFW-SXX-001
NaviCirc™ kit
 Includes 1/2" hoses and adapters
 30022965A



NaviClean
magnetic filtration system
 Removes higher levels of iron oxides, sludge and debris with powerful magnetic filter.
 GXXX001727



PeakFlow-S
standard scale prevention system
 GPWC1101AC001



Residential neutralizer (V2)
 1 unit
 GXXX002212
Residential replacement media
 GXXX001323

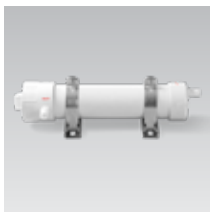

Light commercial neutralizer
 GXXX001324
Light commercial replacement media
 GXXX001328



HotButton
components
Wall plate
 GXXX001427
Push button
 GXXX001426



Common vent collar kit
 30014367B
 Includes cascade cable (GXXX000546), common vent collar damper and VID jumper cable.



SmartZone+
pump controller
 2 Zones: PFMZ-02P-001
 3 Zones: PFMZ-03P-001
 4 Zones: PFMZ-04P-001
 6 Zones: PFMZ-06P-001



Combi-boiler primary manifold kit for NCB-H and NFC-H
 This package includes new stainless steel manifold, isolation valves with gaskets, PRV/air vent/LWCO adapter tree, air vent, threaded connection adapter with clip and LWCO plug.
 30026576B



Plumb easy valve set (V2) 3/4" with relief valve
 GXXX002139



Ready-Link
communication cable
 GXXX000546

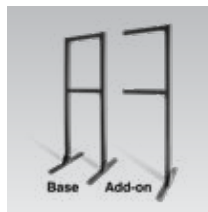

Universal temperature sensor
 GXXX001769

Ready-Link
rack
Base (V3)
 GFFMKDIZUS-005
Add-on (V3)
 GFFMKDIZUS-006

NCB-H



NCB-H

NCB-H Series

NAVIEN HIGH CAPACITY WATER TUBE CONDENSING COMBI-BOILERS



Dimensions

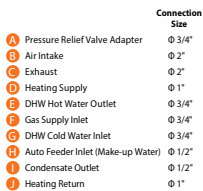
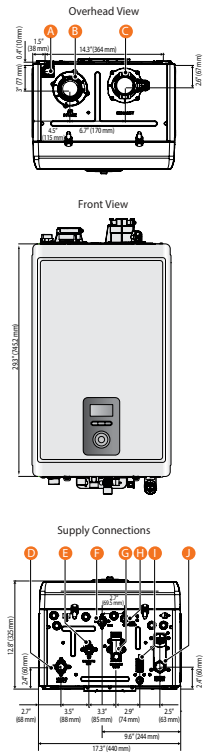

Specifications

Item	Model		
	NCB-190/060H NCB-190/080H	NCB-240/110H NCB-240/130H	NCB-250/150H
Dimensions	17.3" W x 29.3" H x 12.8" D		
Boiler weight	Empty	87 lbs (40 kg)	96 lbs (44 kg)
	With water	93 lbs (42 kg)	102 lbs (46 kg)
Installation type	Indoor wall-hung		
Venting type	Forced draft direct vent		
Ignition	Electronic ignition		
Natural gas supply pressure (from source)	3.5" to 10.5" WC		
Propane gas supply pressure (from source)	8.0" to 13.5" WC		
Natural gas manifold pressure	-0.01" WC to -0.31" WC	-0.06" WC to -0.24" WC	-0.06" WC to -0.26" WC
Propane gas manifold pressure	-0.04" WC to -0.33" WC	-0.06" WC to -0.26" WC	-0.06" WC to -0.28" WC
Gas connection size	3/4" NPT		
Power supply	Main supply	120V AC, 60Hz	
	Maximum power consumption	Up to 15 amperes	
Materials	Casing	Cold-rolled carbon steel	
	Heat exchangers	Stainless steel	
Venting	Exhaust	2" or 3" PVC, CPVC, approved polypropylene 2" or 3" special gas vent type BH (Class III, A/B/C) 2" or 3" stainless steel	
	Intake	2" or 3" PVC, CPVC, polypropylene 2" or 3" special gas vent type BH (Class III, A/B/C) 2" or 3" stainless steel	
	Vent clearance	0" to combustibles	
Safety devices	Flame Rod, APS, Ignition operation detector, water temperature high limit switch, exhaust temperature high limit sensor, water pressure sensor, burner high limit fuse, vent installation detector		

Navien reserves the right to change specifications at any time without prior notice. Please refer to www.NavienInc.com to verify you have the most current information.

DHW Temp Rise °F (°C)	DHW Flow Rates GPM (L/m)		
	NCB-190/060H NCB-190/080H	NCB-240/110H NCB-240/130H	NCB-250/150H
35 (19)	8.2 (31.1)	10.4 (39.5)	10.8 (40.9)
40 (22)	7.2 (27.3)	9.0 (34.1)	9.5 (35.8)
45 (25)	6.4 (24.2)	7.9 (30.0)	8.4 (31.8)
50 (28)	5.8 (21.8)	7.2 (27.3)	7.6 (28.6)
55 (31)	5.2 (19.8)	6.6 (25.0)	6.9 (26.0)
60 (33)	4.8 (18.2)	6.0 (22.7)	6.3 (23.8)
67 (37)	4.3 (16.3)	5.4 (20.4)	5.6 (21.4)
70 (39)	4.1 (15.6)	5.1 (19.3)	5.4 (20.4)
77 (43)	3.7 (14.2)	4.7 (17.8)	4.9 (18.6)
80 (44)	3.6 (13.6)	4.5 (17.0)	4.7 (17.9)
85 (47)	3.4 (12.8)	4.2 (15.9)	4.4 (16.8)
90 (50)	3.2 (12.1)	4.0 (15.1)	4.2 (15.9)
100 (56)	2.9 (10.9)	3.6 (13.6)	3.8 (14.3)

Model Transition	
Discontinued NCB-E	New NCB-H
NCB-150E DHW: 12,000–120,000 BTU/h HTG: 60,000 BTU/h	NCB-190/060H DHW: 10,700–160,000 BTU/h HTG: 60,000 BTU/h
NCB-180E DHW: 14,000–150,000 BTU/h HTG: 80,000 BTU/h	NCB-190/080H DHW: 10,700–160,000 BTU/h HTG: 80,000 BTU/h
NCB-210E DHW: 18,000–180,000 BTU/h HTG: 100,000 BTU/h	NCB-240/110H DHW: 13,300–199,900 BTU/h HTG: 110,000 BTU/h
NCB-240E DHW: 18,000–199,900 BTU/h HTG: 120,000 BTU/h	NCB-240/130H DHW: 13,300–199,900 BTU/h HTG: 130,000 BTU/h
	AN INDUSTRY FIRST
	NCB-250/150H DHW: 14,000–210,000 BTU/h HTG: 150,000 BTU/h



Ratings

Model Number ¹	Navien Condensing Boiler Space Heating Ratings 					Other Specifications	
	Heating Input (BTU/h)		Heating Capacity ² (BTU/h)	Net AHRI Rating Water ³ (BTU/h)	AFUE ² (%)	Water Pressure	Water Connection Size (Supply, Return)
	Min	Max					
NCB-190/060H	11,000	60,000	56,000	49,000	95.0	12-30 psi	1" NPT
NCB-190/080H	11,000	80,000	74,000	64,000			
NCB-240/110H	13,000	110,000	102,000	89,000			
NCB-240/130H	13,000	130,000	120,000	104,000			
NCB-250/150H	14,000	150,000	138,000	120,000			

¹ Ratings are the same for natural gas models converted to propane use.

² Based on U.S. Department of Energy (DOE) test procedures.

³ The net AHRI water ratings shown are based on a piping and pickup allowance of 1.15.

Consult Navien before selecting a boiler for installations having unusual piping and pickup requirements, such as intermittent system operation, extensive piping systems, etc.



Navien Condensing Boiler Domestic Hot Water Ratings			Other Domestic Hot Water Specifications				
Model Number	Input Ratings (BTU/h)		Water Pressure PSI	Minimum Flow Rate GPM (L/m)	Flow Rate 77°F (43°C) Temp Rise GPM (L/m)	DHW Connection Size	
	Min	Max				Inlet	Outlet
NCB-190/060H	10,700	160,000	15-150	0.5 (1.9)	3.7 (14.2)	3/4" NPT	3/4" NPT
NCB-190/080H							
NCB-240/110H							
NCB-240/130H	13,300	199,900			4.7 (17.8)		
NCB-250/150H					14,000		

Navien certification summary

Item	Model				
	NCB-190/060H	NCB-190/080H	NCB-240/110H	NCB-240/130H	NCB-250/150H
Product Approvals					
CSA	Yes	Yes	Yes	Yes	Yes
SCAQMD 1146.2 (NOx, <20 ppm)	Yes	Yes	Yes	Yes	Yes
Low Lead (<0.25%, DHW only)	Yes	Yes	Yes	Yes	Yes
ASME	Yes "H" stamp	Yes "H" stamp	Yes "H" stamp	Yes "H" stamp	Yes "H" stamp
AHRI Number	205661696	205661697	205400817	205400818	205400819
Energy Star	Yes	Yes	Yes	Yes	Yes
Space Heating Ratings					
AFUE, %	95.0	95.0	95.0	95.0	95.0
Heating Capacity, BTU/h	56,000	74,000	102,000	120,000	138,000

Input

Model	Heating (BTU/h)	DHW (BTU/h)
NCB-190/060H	11,000-60,000	10,700-160,000
NCB-190/080H	11,000-80,000	
NCB-240/110H	13,000-110,000	13,300-199,900
NCB-240/130H	13,000-130,000	
NCB-250/150H	14,000-150,000	14,000-210,000

Temperature range settings

Item	Temperature Range °F (°C)	Remarks
Space Heating	Supply 77-185 (25-85)	Actual supply and return temperatures vary depending on the selected outdoor reset curve.
	Return 68-158 (20-70)	
DHW	86-140 (30-60)	

Applications

Air Handler	Closed Loop Hydronic Heating Systems
For NCB-H technical drawings of specific installations and requirements please visit Navieninc.com	

Warranty

Type	Residential Single Family Use Only
Heat exchanger	10 year
Parts*	5 year
Labor	1 year

*Includes DHW flat plate HX.



NFC-H NAVIEN FIRE TUBE CONDENSING HIGH CAPACITY COMBI-BOILERS

Highest heating and DHW performance ever built into one compact combi-boiler

Navien innovation, durability and proven fire tube technology has done it again. The new NFC-H has more heating and DHW capacities for today's larger progressive homes. Navien continues to reinvent smarter ways to bring high efficiency home comfort to your customers. Also, Navien continues to make installation and set-up easier for contractors.

- **Highest** DHW maximum BTUs in residential combi-boilers... 210,000 per hour
- **Highest** DHW flow rate @ 70°F rise...up to 5.4 GPM
- **Highest** residential combi DHW 15:1 TDR
- **Highest** residential combi heating TDR...up to 15:1*
- **Highest** full lineup 2" venting lengths...up to 65 feet
- **Highest** number of built-in zone pump or zone valve connections: 3
- **Highest** number of cascade capable units with NPE-2 tankless water heaters...up to 15
- **High altitude certification**...up to 10,100 feet (NG or LP)

*Based on NFC-250/200H.

PATENTED
SS FIRE TUBE
HX FOR HEATING

SEPARATE
HIGH FLOW
SS DHW HX

ADVANCED
USER INTERFACE

TDR UP TO
15:1 HTG
DHW

NG or LP or NG HIGH
ALTITUDE
FIELD GAS CONVERTIBLE

3 ZONES
VALVES or PUMPS

2" VENT UP TO
65 FEET & 1/2" GAS
UP TO 24 FEET

AFUE
95.0%



NFC-H Series

Patented stainless steel fire tube heat exchanger

Navien's innovative heat exchanger design is ASME-Certified, "H" Stamped, and reduces high stress point weld failures common on other combi-boilers.

Low profile burner removes easily and improves serviceability.

Innovative heat exchanger design allows water to fill to the top eliminating extra combustion chamber insulation.

One-piece combustion chamber minimizes the number of weld points prone to corrosion.

EPP exterior insulation reduces heat loss and increases efficiency.

Turbulators inside the tubes increase structural strength and creates a gas cyclone effect maximizing heat transfer efficiency.

New diaphragm design optimizes water flow and improves performance.

Non-metallic drain pan prevents corrosion caused by acidic condensate, unlike competitor's metal pans.

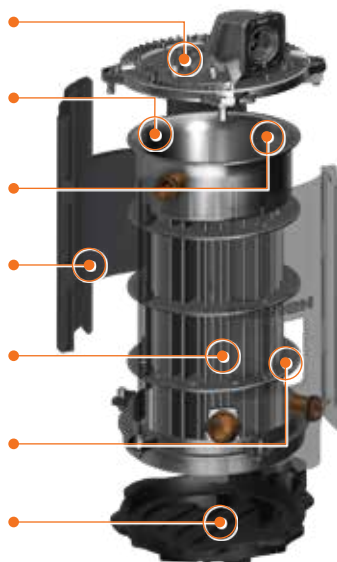

Built-in DHW module with higher performance

Navien's innovative DHW heat exchanger generates enough hot water to run up to 3 showers and a dishwasher, all at the same time.

Integrated boiler pump for hydronic space heating and DHW. No need for an external pump saving installation time, space and costs.

NEW mixing valve.

NEW easy access 3-way valve.

DHW stainless steel flat plate heat exchanger 5.6 GPM @ 67°F temperature rise. One of the highest flow rates in the industry.

NEW flow adjustment valve.

Water feed valve.

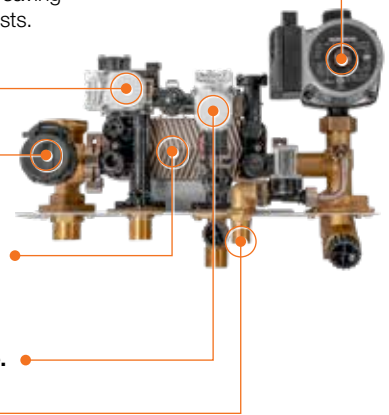

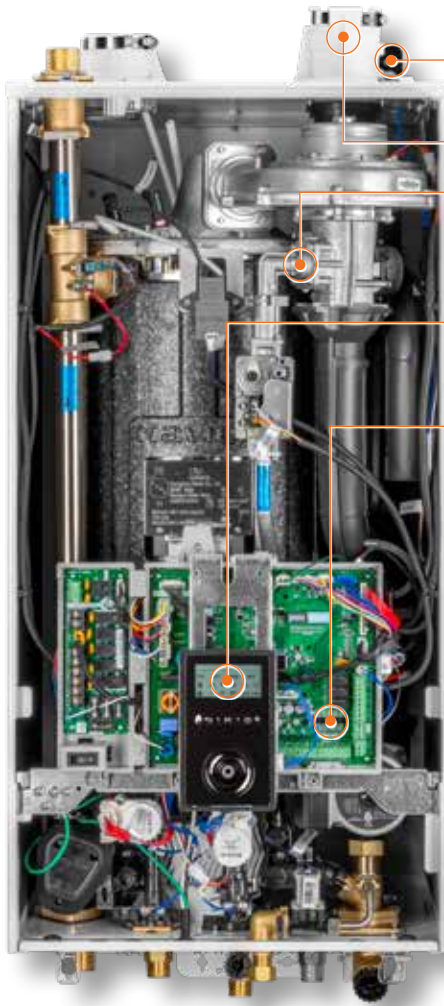

- **Vent Installation Detector (VID).**
- **2" venting up to 65'** (including schedule 40 PVC).
- **Dual Venturi and field gas convertibility.** Dual Venturi system creates better combustion control and turndown ratio. Field gas convertibility is easy with orifice conversion kits for NG high altitude (5,400–10,100 ft.) and LP (up to 10,100 ft.) included with NFC-H series combi-boilers. 
- **Advanced user interface control with setup wizard.** Navien's new backlit control panel is simple and intuitive to use with its plain text display and an innovative click wheel that improves usability for all information input.
- **Built-in control for 3-zone pumps or 3-zone valves.** Connections are powered, not just dry contact relays. The supplied power by PCB board is 120VAC for zone pumps and 24VAC for zone valves.



NFC-H

Best combi capacity on the market



HEATING UP TO 199,900 BTU/h
DHW 210,000 BTU/h



NFC-H

NFC-H Series

NAVIEN HIGH CAPACITY FIRE TUBE CONDENSING COMBI-BOILERS



Compare these advantages and see why NCB-H combis are the right fit for any size family



Dual inputs of 210,000 BTU/h for DHW and up to 199,900 BTU/h for heating

Satisfies all the space heating and domestic hot water requirements of most typical large homes.



2" PVC venting and 1/2" gas pipe capability

Save time and effort in retrofit application with 2" PVC venting up to 65' or up to 150' with 3" venting. 1/2" gas lines for up to 24' also speeds up installations.

Safety vent sensor

Vent Installation Detector (VID).

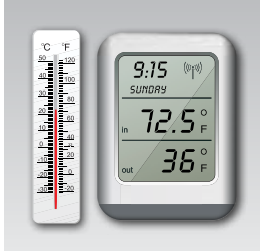

TDR up to 15:1 for heating and for DHW

The sophisticated gas flow control system provides a high turndown ratio, reducing energy waste and excessive boiler cycling and enhances temperature control for DHW.



Space saving and lightweight design

Navien's sleek wall-hung combi-boilers occupy 80% less space than traditional floor standing boilers and tank water heaters.



Quiet running

Navien products are engineered to operate at comfortably low noise levels.



Expanded DHW capability

For increased domestic hot water flow demand, the NFC-H can be cascaded with up to 15 NPE-2 tankless water heaters.

NFC-H Series combi-boiler accessories



NaviLink®
Wi-Fi control
 PBCM-AS-001
Expansion cable
 GXXX001659



NaviLink®
Wi-Fi control
 PBCM-AS-002



HotButton®
components
Wall plate
 GXXX001427
Push button
 GXXX001426



NaviCirc®
recirculation valve
NaviCirc™
 PFFW-SXX-001
NaviCirc™ kit
 Includes 1/2" hoses and adapters
 30022965A



PeakFlow-S®
standard scale
prevention system
 GPWC1101AC001



NaviClean®
magnetic filtration system
 Removes higher levels of iron oxides,
 sludge and debris with powerful
 magnetic filter.
 GXXX001727



Combi-boiler primary manifold kit
for NFC-H and NCB-H
 This package includes new stainless steel
 manifold, isolation valves with gaskets,
 PRV/air vent/LWCO adapter tree, air vent,
 threaded connection adapter with clip
 and LWCO plug.
 30026576B



SmartZone+®
pump controller
 2 Zones: PFMZ-02P-001
 3 Zones: PFMZ-03P-001
 4 Zones: PFMZ-04P-001
 6 Zones: PFMZ-06P-001



Common vent collar kit
 30014367B
 Includes cascade cable (GXXX000546),
 common vent collar damper and
 VID jumper cable.



Commercial neutralizer
 Commercial condensate neutralizer for up
 to 16 units (1 NFC-H and up to 15 NPE's).
 GXXX001325
Commercial replacement media
 GXXX001329

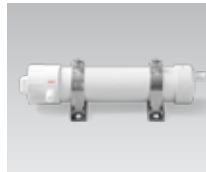

Light commercial neutralizer
 GXXX001324
Light commercial replacement media
 GXXX001328



Residential neutralizer (V2)
 1 unit
 GXXX002212
Residential replacement media
 GXXX001323



Plumb easy valve 3/4"
with relief valve
 30009323A



Ready-Link®
communication cable
 GXXX000546



Universal temperature sensor
 GXXX001769

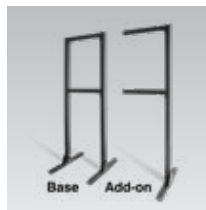

Ready-Link®
rack
Base (V3)
 GFFMKDIZUS-005
Add-on (V3)
 GFFMKDIZUS-006





NFC-H

NFC-H Series

NAVIEN HIGH CAPACITY FIRE TUBE CONDENSING COMBI-BOILERS



Dimensions

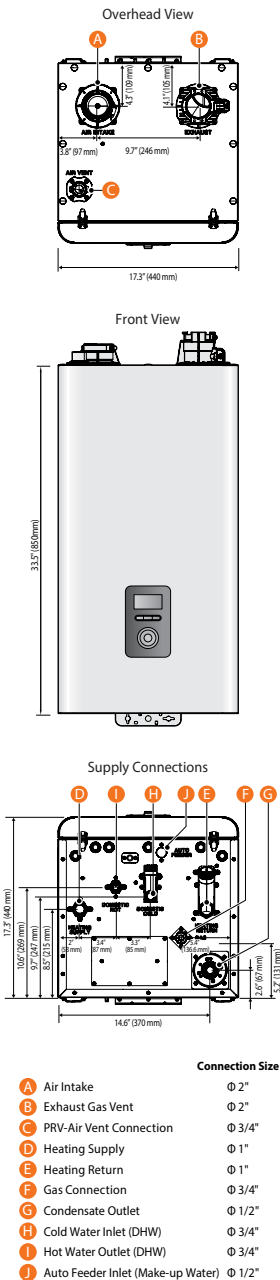

Specifications

Item	Model	
	NFC-250/175H	NFC-250/200H
Dimensions	17.3" W x 17.3" D x 33.5" H	
Boiler weight	141 lb (64 kg)	
Boiler weight with water	170 lb (77 kg)	
Installation type	Indoor wall-hung	
Venting type	Forced draft direct vent	
Ignition	Electronic ignition	
Natural Gas supply pressure (from source)	3.5" to 10.5" WC	
Propane Gas supply pressure (from source)	8.0" to 13.5" WC	
Natural Gas manifold pressure	-0.03" to -0.92" WC	
Propane Gas manifold pressure	-0.02" to -0.77" WC	
Gas connection size	3/4" NPT	
Power supply	Main supply	120V AC, 60Hz
	Maximum power consumption	Less than 15 amperes
Materials	Casing	Cold-rolled carbon steel
	Heat exchanger	Stainless steel
Venting	Exhaust	2" or 3" PVC, CPVC, approved polypropylene 2" or 3" special gas vent type BH (Class III, A/B/C) 2" or 3" stainless steel
	Intake	2" or 3" PVC, CPVC, polypropylene 2" or 3" special gas vent type BH (Class III, A/B/C) 2" or 3" stainless steel
	Vent clearance	0" to combustibles
Safety devices	Flame rod, APS, ignition operation detector, water temperature high limit switch, exhaust temperature high limit sensor, water pressure sensor, burner high limit fuse, Vent Installation Detector (VID)	

Navien reserves the right to change specifications at any time without prior notice. Please refer to www.Navieninc.com to verify you have the most current information.

NFC-250/175H and NFC-250/200H Series	
Temp. Rise °F (°C)	Flow Rate GPM (L/m) ¹
35 (19)	10.8 (40.9)
40 (22)	9.5 (35.8)
45 (25)	8.4 (31.8)
50 (28)	7.6 (28.6)
55 (31)	6.9 (26.0)
60 (33)	6.3 (23.8)
67 (37)	5.6 (21.4)
70 (39)	5.4 (20.4)
77 (43)	4.9 (18.6)
80 (44)	4.7 (17.9)
85 (47)	4.4 (16.8)
90 (50)	4.2 (15.9)
100 (56)	3.8 (14.3)

¹ Max GPM based on installation conditions.





Ratings

Model Number ¹	Navien Combination Condensing Boiler Space Heating Ratings 				Other Space Heating Specifications			
	Heating Input (BTU/h)		Heating Capacity ² (BTU/h)	Net AHRI Rating Water ³ (BTU/h)	AFUE ² %	Water Pressure	Water Connection Size (Supply, Return)	Water Volume
	Min	Max						
NFC-250/175H	13,300	175,000	161,000	140,000	95.0	12–80 psi	1" NPT	4.5 gallons
NFC-250/200H	13,300	199,900	183,000	159,000				

¹ Ratings are the same for natural gas models converted to propane use.

² Based on U.S. Department of Energy (DOE) test procedures.

³ The net AHRI water ratings shown are based on a piping and pickup allowance of 1.15.

Consult Navien before selecting a boiler for installations having unusual piping and pickup requirements, such as intermittent system operation, extensive piping systems, etc.



Navien Combination Condensing Boiler Domestic Hot Water Ratings			Other Domestic Hot Water Specifications				
Model Number	Input Ratings (BTU/h)		Water Pressure PSI	Minimum Flow Rate GPM (L/m)	Flow Rate 77°F (43°C) Temp Rise GPM (L/m)	DHW Connection Size	
	Min	Max				Inlet	Outlet
NFC-250/175H	13,300	210,000	15–150	0.5 (1.9)	4.9 (18.6)	3/4" NPT	3/4" NPT
NFC-250/200H							

Navien certification summary

Item	Model	
	NFC-250/175H	NFC-250/200H
Product Approvals		
CSA	Yes	Yes
SCAQMD 1146.2 (NOx, <20 ppm)	Yes	Yes
Low Lead (<0.25%, DHW only)	Yes	Yes
ASME	Yes "H" stamp	Yes "H" stamp
AHRI Number	206368824	206368825
Energy Star	Yes	Yes
Space Heating Ratings		
AFUE, %	95.0	95.0
Heating Capacity, BTU/h	161,000	183,000

Applications

Air Handler	Closed Loop Hydronic Heating Systems
For NFC-H technical drawings of specific installations and requirements, please visit Navieninc.com	

Input

Model	Heating (BTU/h)	DHW (BTU/h)
NFC-250/175H	13,300–175,000	13,300–210,000
NFC-250/200H	13,300–199,900	13,300–210,000

Temperature Range Settings

Item	Temperature Range °F (°C)	Remarks
Space heating	Supply 77–185 (25–85)	Actual supply and return temperatures vary depending on the selected outdoor reset curve.
	Return 68–158 (20–70)	
DHW	86–140 (30–60)	

Warranty

Type	Residential*	Commercial
Heat exchanger	10 years	5 years
Parts*	5 years	3 years
Labor	1 year	1 year

*Applies to single family residential locations.

For complete details please refer to the full warranty at Navieninc.com.

NHB NAVIEN WATER TUBE CONDENSING HEATING BOILERS

Navien innovation in a compact high efficiency wall-hung boiler

The NHB Series: Industry's highest TDR at up to 15:1

As the leader in condensing technology, Navien reinvented the water heating industry with the award-winning NPE tankless water heaters and the NCB-E combi-boilers. Our tradition of innovation continues with the NHB series high efficiency condensing boilers. All NHB boilers have Navien's advanced burner system, an AFUE of 95.0% and industry-leading turndown ratios up to 15:1. The NHB boiler is available in four sizes: 55,000 BTU/h, 80,000 BTU/h, 110,000 BTU/h and 150,000 BTU/h.

- Dual stainless steel heat exchangers for advanced durability
- Schedule 40, 2" PVC venting up to 60 feet
- 1/2" gas pipe up to 40 feet (subject to local codes)

TDR **UP TO 15:1**

AFUE **95.0%**

2"-3" VENTING
LONG DISTANCES

NG OR LP FIELD GAS
CONVERTIBLE

ADVANCED
BOILER CONTROL

1/2" GAS CAPABILITY
UP TO 24 FT



NHB Series

Before



After



Sleek wall-hung design uses up to 80% less space than other boilers.



NHB 110 and 150: Common vent up to 8 units and cascade up to 16 units





2" PVC venting up to 60', 3" up to 150'.

Low exhaust gas temperatures allow use of PVC (including schedule 40 PVC), CPVC, polypropylene (rigid and flexible) and stainless steel venting saving time and costs.



The condensing technology in the stainless steel heat exchangers of the NHB boilers saves energy, reduces greenhouse gasses.

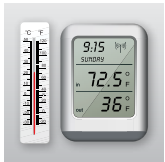

Turndown ratio up to 15:1 on NHB.

The sophisticated gas flow control system provides a high turndown ratio which reduces energy waste and excessive boiler cycling.



NHB integrated control provides industry leading options and features:

- Adjustable heat capacity
- Temp boost for outdoor reset control
- Adjustable anti-cycle timer
- Freeze protection
- Pressure LWCO with manual reset
- Adjustable minimum burner time setting
- Outdoor reset and DHW priority
- Adjustable outdoor temp reset curves
- Field gas convertible

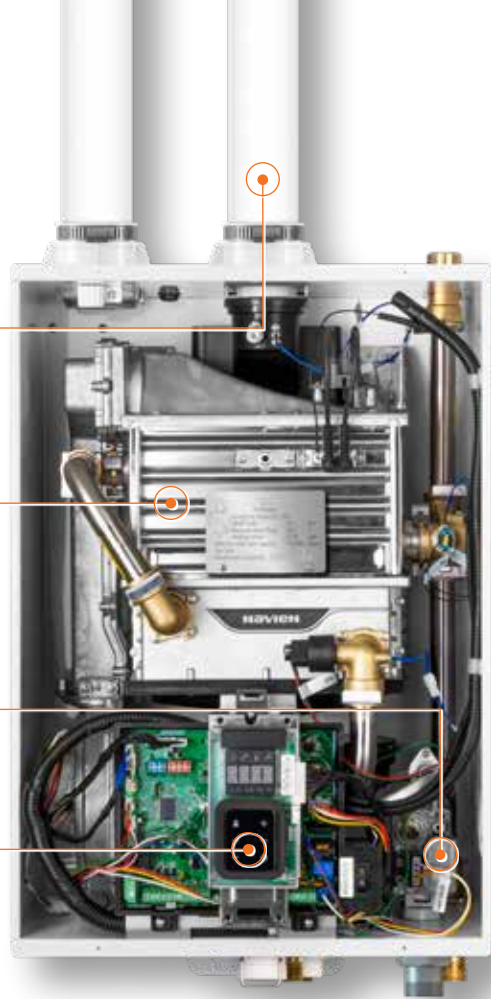

NHB



With Navien's cascading technology, when a unit gets up to capacity determined by the supply and return temperatures, the next unit will start to help meet the hydronic space heating requirements.



NHB

NHB Series

NAVIEN WATER TUBE CONDENSING HEATING BOILERS



Navien NHB boiler system matched manifold kits

NHB Primary Manifold Kit

GFFM-MSOZUS-001

NHB Secondary Manifold Kit

GFFM-SKTZUS-001

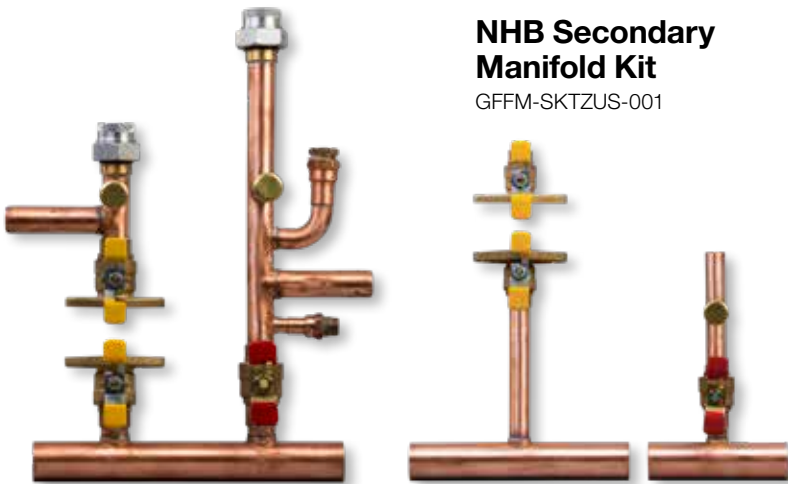

Navien has done the piping work for you. Both primary and secondary loop manifold kits are designed to work on all NHB models for fast and clean installations. All you need to add is your own appropriately sized pump.



Advanced filtration for hydronic heating systems

Optional NaviClean® magnetic boiler filter

NaviClean® is designed to work with Navien boilers and combi-boilers. Works with flow rates up to 21 GPM. It features a permanent magnet mounted inside the nylon housing.

- Powerful permanent magnet for removing higher levels of iron oxide, sludge and debris
- 360° rotation allows flexibility of installation
- Inlet and outlet ports for rapid in-line installation
- Tool-free valve connection prevents cross threading
- Large canister and full flow valves result in minimal pressure drop and unrestricted flow
- Low profile drain valve makes installation and service easier
- High performance seals provide higher protection against leaks



In minutes, the NaviClean® filter traps the debris, and water is clear





NHB Series boiler accessories



NaviLink®
Wi-Fi control
PBCM-AS-001
Expansion cable
GXXX001659



SmartZone+
pump controller
2 Zones: PFMZ-02P-001
3 Zones: PFMZ-03P-001
4 Zones: PFMZ-04P-001
6 Zones: PFMZ-06P-001



NaviLink®
Wi-Fi control
PBCM-AS-002



Common vent collar kit
30014367B
Includes cascade cable (GXXX000546), common vent collar damper and VID jumper cable.



NaviClean®
magnetic filtration system
Removes higher levels of iron oxides, sludge and debris with powerful magnetic filter.
GXXX001727

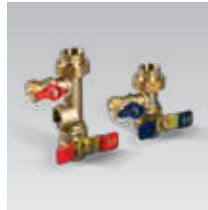

Plumb easy valve set, 1"
1" isolation valves without relief valve designed to work on NHB series units. Allows for easy and quick servicing of hydronic space heating systems.
30010950A



Commercial neutralizer
Designed to neutralize the condensate of up to 16 NHB series units.
GXXX001325
Commercial replacement media
GXXX001329



Universal temperature sensor
Designed to sense supply, return or tank temperature of hydronic heating system. Works with all NHB series boilers.
GXXX001769

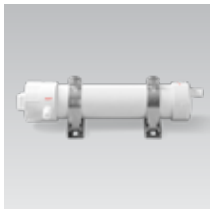

Light commercial neutralizer
Designed to neutralize the condensate of up to 6 NHB series units.
GXXX001324
Light commercial replacement media
GXXX001328



Ready-Link®
communication cable
GXXX000546



Residential neutralizer (V2)
Residential condensate neutralizer for NHB series units designed to neutralize the condensate of one unit.
GXXX002212
Residential replacement media
GXXX001323

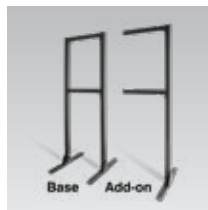

Ready-Link®
rack
Base (V3)
GFFMKDIZUS-005
Add-on (V3)
GFFMKDIZUS-006

NHB



NHB

NHB Series

NAVIEN WATER TUBE CONDENSING HEATING BOILERS



Dimensions

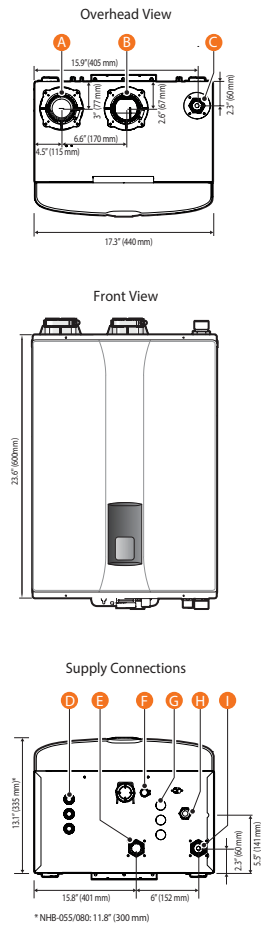

- | Connection Size | |
|------------------------|--------|
| A Air Intake | Ø 2" |
| B Exhaust Gas Vent | Ø 2" |
| C Air Vent Connection | Ø 3/4" |
| D Rubber Grommet | Ø 1" |
| E Space Heating Return | Ø 1" |
| F Condensate Outlet | Ø 1/2" |
| G Knock Out Hole | Ø 3/4" |
| H Gas Connection | Ø 3/4" |
| I Space Heating Supply | Ø 1" |

Specifications

Item	Model			
	NHB-55	NHB-80	NHB-110	NHB-150
Dimensions	24" (H) x 17" (W) x 12" (D)		24" (H) x 17" (W) x 13" (D)	
Weight	73 lbs (33 kg)		80 lbs (36 kg)	
Installation type	Indoor wall-hung			
Venting type	Forced draft direct vent			
Ignition	Electronic ignition			
Natural gas supply pressure (from source)	3.5" –10.5" WC			
Propane gas supply pressure (from source)	8.0" –13.5" WC			
Natural gas manifold pressure	-0.03" WC	-0.08" WC	-0.10" WC	-0.40" WC
Propane gas manifold pressure	-0.03" WC	-0.07" WC	-0.09" WC	-0.30" WC
Gas connection size	3/4" NPT (female)			
Power supply	Main supply	120V AC, 60Hz		
	Maximum power consumption	Less than 10A		
Materials	Casing	Cold rolled carbon steel		
	Heat exchangers	Primary and secondary heat exchangers: stainless steel		
Venting	Exhaust	2" or 3" PVC, CPVC, PP, SS (see installation manual for more details) 2" or 3" special gas vent type BH (Class III, A/B/C)		
	Intake	2" or 3" PVC, CPVC, PP, SS 2" or 3" special gas vent type BH (Class III, A/B/C)		
	Vent clearances	0" to combustibles		
Safety devices	Flame rod, aps, gas valve operation detector, ignition operation detector, water temperature high limit switch, exhaust temperature high limit sensor			

Navien reserves the right to change specifications at any time without prior notice. Please refer to Navieninc.com to verify you have the most current information.





Ratings

Navien Condensing Boiler Space Heating Ratings					
Model Number ¹	Heating Input (BTU/h)		Heating Capacity ² (BTU/h)	Net AHRI Rating, Water ³ (BTU/h)	AFUE ² , %
	Min	Max			
NHB-55	8,000	55,000	51,000	44,000	95.0
NHB-80	8,000	80,000	74,000	64,000	95.0
NHB-110	10,000	110,000	102,000	89,000	95.0
NHB-150	10,000	150,000	138,000	120,000	95.0

¹Ratings are the same for Natural Gas models converted to Propane use.

²Based on U.S. Department of Energy (DOE) test procedures.

³The NET AHRI Water Ratings shown are based on a piping and pickup allowance of 1.15.

Consult Navien before selecting a boiler for installations having unusual piping and pickup requirements, such as intermittent system operation, extensive piping systems, etc.

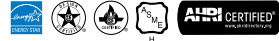

Navien certification summary

Item	Model			
	NHB-55	NHB-80	NHB-110	NHB-150
Product Approvals				
CSA	Yes	Yes	Yes	Yes
SCAQMD 1146.2 (NO _x , <20 ppm)	Yes	Yes	Yes	Yes
ASME	Yes "H" stamp	Yes "H" stamp	Yes "H" stamp	Yes "H" stamp
AHRI Number	7501495	7501496	7501497	7501498
Energy Star	Yes	Yes	Yes	Yes
Space Heating Ratings				
AFUE, %	95.0	95.0	95.0	95.0
Heating Capacity (BTU/h)	51,000	74,000	102,000	138,000

Input

Model	Range (BTU/h)	TDR
NHB-55	8,000–55,000	7:1
NHB-80	8,000–80,000	10:1
NHB-110	10,000–110,000	11:1
NHB-150	10,000–150,000	15:1

Warranty

Type	Residential*	Commercial
Heat Exchangers	15 year limited warranty	10 year limited warranty
Parts	5 years	3 years
Labor	1 year	1 year

*Applies to single family residential locations.

For complete details please refer to the full warranty at NavienInc.com.



NFB-H NAVIEN HIGH CAPACITY CONDENSING FIRE TUBE BOILERS

Navien keeps raising the bar higher and higher in fire tube boiler innovations

We totally reinvented fire tube technology from the ground up and we continue to advance our boiler technology to a higher level with the new NFB-H boiler series.

- Patented stainless steel fire tube heat exchanger — reduces high stress point welds
- Advanced user interface with intuitive text display and Quick Dial Wheel for easy navigation
- Smart controls with Setup Wizard to simplify boiler start up
- Built-in 3 zone pumps or 3 zone valves powered connections
- Optional NaviLink® Wi-Fi remote control
- Common venting up to 8 boilers
- Cascade up to 16 boilers
- Up to 15:1 turndown ratio
- AFUE 95.0% — Energy Star certified
- Compact, light weight, wall hung design saves space over traditional floor standing boilers

PATENTED
STAINLESS STEEL
FIRE TUBE HX

ADVANCED
USER INTERFACE

TDR UP TO
15:1

3 ZONES
VALVES or PUMPS

NG or LP FIELD GAS
CONVERTIBLE

2" VENT UP TO 65 FEET & 3" VENT UP TO 150 FEET

AFUE
95.0%

1/2" GAS CAPABILITY UP TO 24 FT



NFB-H Series

Patented compact stainless steel fire tube heat exchanger

Navien's advanced in-house design/built patented stainless steel heat exchanger is ASME-Certified, "H" Stamped, and reduces high stress point weld failures common on other boilers.

Low profile burner removes easily and improves serviceability, unlike other's bulky cylindrical burners.

Innovative heat exchanger design allows water to fill to the top eliminating extra combustion chamber insulation and improving durability.

One-piece combustion chamber minimizes number of weld points prone to corrosion.

EPP exterior insulation reduces heat loss and increases efficiency.

Turbulators inside the tubes increase structural strength and create a cyclone effect of flue gases maximizing heat transfer and efficiency.

New diaphragm design optimizes water flow and improves performance.

Non-metallic drain pan prevents corrosion caused by acidic condensate, unlike competitor's metal pans.

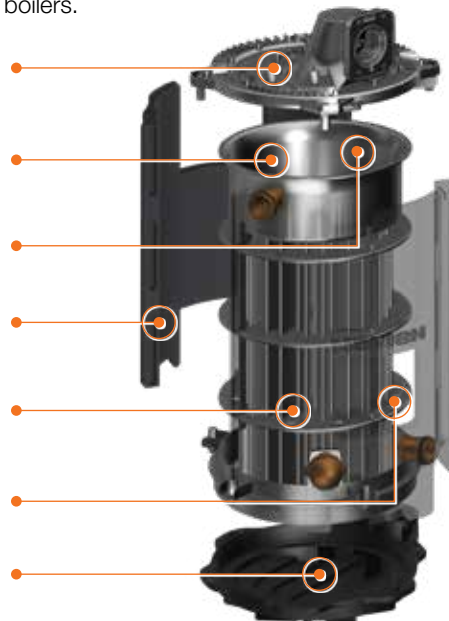

Built-in control for a boiler pump, 3 zone pumps or 3 zone valves

The NFB-H boiler's PCB provides the ability to connect a boiler pump, 3 zone pumps or 3 zones valves, and to set temperatures independently in each zone (see NFB-H Installation Manual for details).





2" PVC venting up to 65', 3" up to 150'.

Low exhaust gas temperatures allow use of PVC (including schedule 40 PVC), CPVC, polypropylene (rigid and flexible) and stainless steel venting saving time and costs.

• **Vent Installation Detector (VID)** for added safety.



Dual Venturi and field gas convertibility.

Dual Venturi system creates better combustion control and turndown ratio. Field gas convertibility is easy with orifice conversion kits for NG high altitude (5,400–10,100 ft.) and LP (up to 10,100 ft.) included with NFB-H series boilers.



Low gas pressure operation.

Negative pressure regulating gas valve ensures maximum performance all the way down to 3.5" of water column on natural gas and 8" of water column on propane gas.



User friendly smart control system with Setup Wizard.

Navien's backlit control panel is simple and intuitive to use with its plain text display and an innovative click wheel that improves usability for all information input.



Uses existing 1/2" gas piping.

Save time and effort in retrofit applications with 1/2" gas lines for up to 24' in length. Subject to local code.

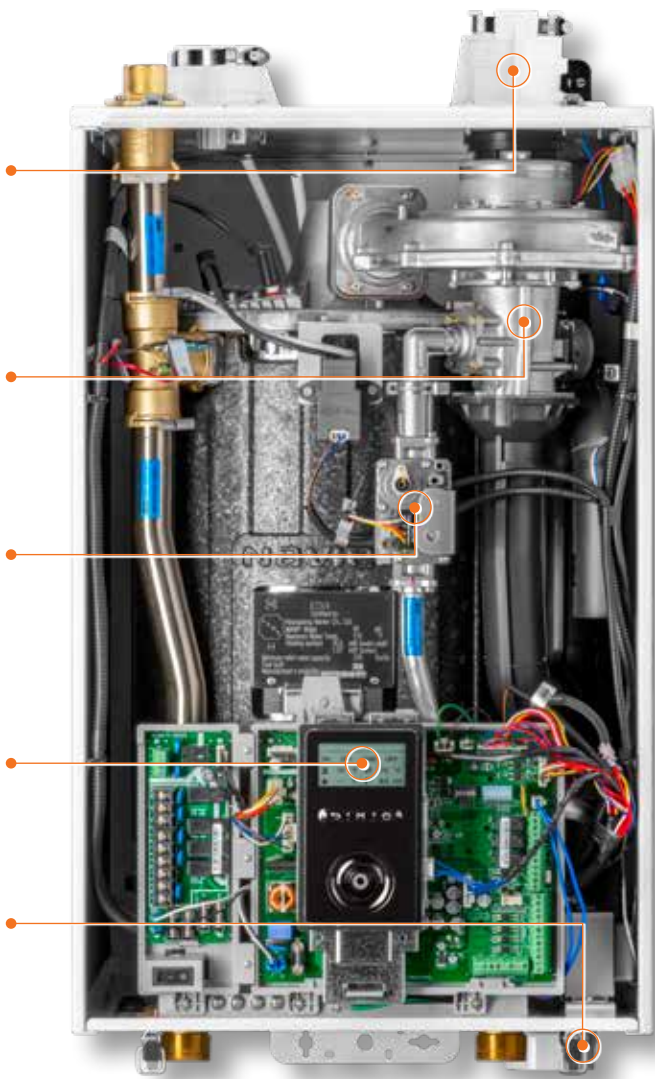

NFB-H



NFB-H

NFB-H Series

NAVIEN HIGH CAPACITY CONDENSING FIRE TUBE BOILERS

Navien NFB-H condensing boilers deliver cost effective solutions for a wide variety of applications

- Single family residences
- Multi family and condominiums
- Office and retail complexes
- Commercial buildings and warehouses
- Restaurants and lodging



Common vent up to 8 units and cascade up to 16 units

With Navien's cascading technology, when a unit gets up to capacity determined by the supply and return temperatures, the next unit will start to help meet the hydronic space heating requirements. This boiler sequence will continue until all units are generating the needed hydronic space heat up to the maximum cascaded capacity. The Navien cascading system also balances out the workload of each unit for longer life. The NFB-H is dual certified for direct and non-direct venting applications.



Before



After



Space saving and lighter weight design

The sleek wall-hung design uses much less space and is substantially lighter than traditional floor standing boilers, making installations a lot easier.



NFB-H Series boiler accessories



NaviLink®
Wi-Fi control
 PBCM-AS-001
Expansion cable
 GXXX001659



SmartZone+⁺
pump controller
 2 Zones: PFMZ-02P-001
 3 Zones: PFMZ-03P-001
 4 Zones: PFMZ-04P-001
 6 Zones: PFMZ-06P-001



NaviLink[®]
Wi-Fi control
 PBCM-AS-002



Common vent collar kit
 Required for cascade/common vent installations with additional NFB-H boilers. 30014367B
 Includes cascade cable (GXXX000546), common vent collar damper and VID jumper cable.



NaviClean[®]
magnetic filtration system
 Removes higher levels of iron oxides, sludge and debris with powerful magnetic filter.
 GXXX001727



NFB-H primary manifold kit
 Navien's NFB-H primary manifold kits are system matched for fast installations and maximum efficiency.
 GFFM-MSOZUS-002



Commercial neutralizer
 Designed to neutralize the condensate of up to 16 NFB-H series units.
 GXXX001325
Commercial replacement media
 GXXX001329



Universal temperature sensor
 Designed to sense supply, return or tank water temperature. Works with all NFB-H series boilers.
 GXXX001769

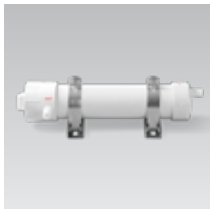

Light commercial neutralizer
 Designed to neutralize the condensate of up to 6 NFB-H series units.
 GXXX001324
Light commercial replacement media
 GXXX001328



Ready-Link[®]
communication cable
 GXXX000546



Residential neutralizer (V2)
 Residential condensate neutralizer for NFB-H series units designed to neutralize the condensate of one unit.
 GXXX002212
Residential replacement media
 GXXX001323

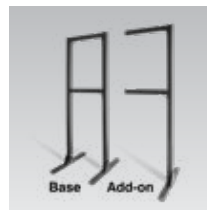

Ready-Link[®]
rack
Base (V3)
 GFFMKDIZUS-005
Add-on (V3)
 GFFMKDIZUS-006



NFB-H

NFB-H Series

NAVIEN HIGH CAPACITY CONDENSING FIRE TUBE BOILERS



Dimensions

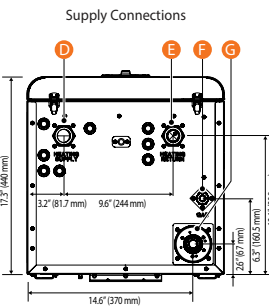
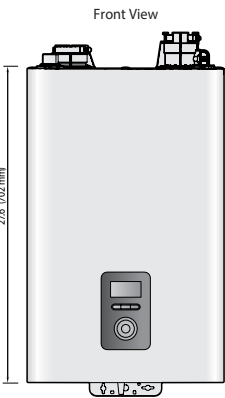
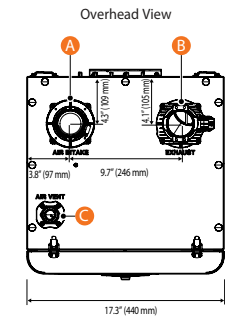

- Connection Size**
- A Air Intake \varnothing 2"
 - B Exhaust Gas Vent \varnothing 2"
 - C Air Vent Connection \varnothing 3/4"
 - D Heating Supply \varnothing 1-1/4"
 - E Heating Return \varnothing 1-1/4"
 - F Gas Connection \varnothing 3/4"
 - G Condensate Outlet \varnothing 1/2"

Specifications

Item	Model	
	NFB-175H	NFB-200H
Dimensions	17.3" W x 17.3" D x 27.6" H	
Boiler weight	121 lb (55 kg)	
Boiler weight with water	148 lb (67 kg)	
Installation type	Indoor wall-hung	
Venting type	Forced draft direct vent	
Ignition	Electronic ignition	
Natural Gas supply pressure (from source)	3.5" to 10.5" WC	
Propane Gas supply pressure (from source)	8.0" to 13.0" WC	
Natural Gas manifold pressure	-0.03" to -0.70" WC	-0.03" to -0.85" WC
Propane Gas manifold pressure	-0.02" to -0.68" WC	-0.02" to -0.75" WC
Gas connection size	3/4" NPT	
Power supply	Main supply	120V AC, 60Hz
	Maximum power consumption	Less than 15 amperes
Materials	Casing	Cold-rolled carbon steel
	Heat exchanger	Stainless steel
Venting	Exhaust	2" or 3" PVC, CPVC, approved polypropylene 2" or 3" special gas vent type BH (Class III, A/B/C) 2" or 3" stainless steel
	Intake	2" or 3" PVC, CPVC, polypropylene 2" or 3" special gas vent type BH (Class III, A/B/C) 2" or 3" stainless steel
	Vent clearance	0" to combustibles
Safety devices	Flame rod, APS, ignition operation detector, water temperature high limit switch, exhaust temperature high limit sensor, water pressure sensor, Vent Installation Detector (VID)	

Navien reserves the right to change specifications at any time without prior notice. Please refer to Navieninc.com to verify you have the most current information.





Ratings

Model Number ¹	Navien Condensing Boiler Space Heating Ratings					Other Specifications		
	Heating Input (BTU/h)		Heating Capacity ² (BTU/h)	Net AHRI Rating Water ³ (BTU/h)	AFUE ² %	Water Pressure	Water Connection Size (Supply, Return)	Water Volume
	Min	Max						
NFB-175H	13,300	175,000	160,000	139,000	95.0	6–80 psi	1-1/4" NPT	4.5 gallons
NFB-200H	13,300	199,900	182,000	158,000	95.0			

¹ Ratings are the same for natural gas models converted to propane use.

² Based on U.S. Department of Energy (DOE) test procedures.

³ The net AHRI water ratings shown are based on a piping and pickup allowance of 1.15.

Consult Navien before selecting a boiler for installations having unusual piping and pickup requirements, such as intermittent system operation, extensive piping systems, etc.

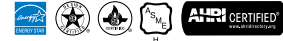

Navien certification summary

Item	Model	
	NFB-175H	NFB-200H
	Product Approvals	
CSA	Yes	Yes
SCAQMD 1146.2 (NO _x , <20 ppm)	Yes	Yes
ASME	Yes "H" stamp	Yes "H" stamp
AHRI Number	206368828	206368829
Energy Star	Yes	Yes
	Space Heating Ratings	
AFUE, %	95.0	95.0
Heating Capacity, BTU/h	160,000	182,000

Input

Model	Range (BTU/h)	TDR
NFB-175H	13,300–175,000	13.2:1
NFB-200H	13,300–199,900	15:1

Warranty

Type	Residential*	Commercial
Heat exchanger	15 year limited warranty	10 years
Parts	5 years	3 years
Labor	1 year	1 year

*Applies to single family residential locations.

For complete details please refer to the full warranty at Navieninc.com.



NFB-C NAVIEN CONDENSING COMMERCIAL FIRE TUBE BOILERS

Navien's high efficiency fire tube condensing technology makes NFB-C hard to beat and the easy choice for today's commercial boiler installs

- Robotic and automated manufacturing technology for unmatched quality control
- In-house designed and built system matched components... unlike most competitors who use the same out-sourced parts in their boilers
- Lower installation costs with our innovative engineered compact wall hung design, intuitive controls, top or bottom piping connections and flexible venting options
- Lower operating costs with the industry's leading thermal efficiency at TE 97.5%...Energy Star approved
- Best-in-class training, technical support and warranty

TE 97.5%

FIRE TUBE STAINLESS STEEL HEAT EXCHANGER

TDR UP TO 15:1

BACNET/LONWORKS BMS COMMUNICATION CAPABLE

160 PSI ASME WORKING PRESSURE

TOP & BOTTOM PIPING

CASCADE UP TO 32 UNITS



NFB-C Series

Cascade up to 32 units and common vent up to 4 units

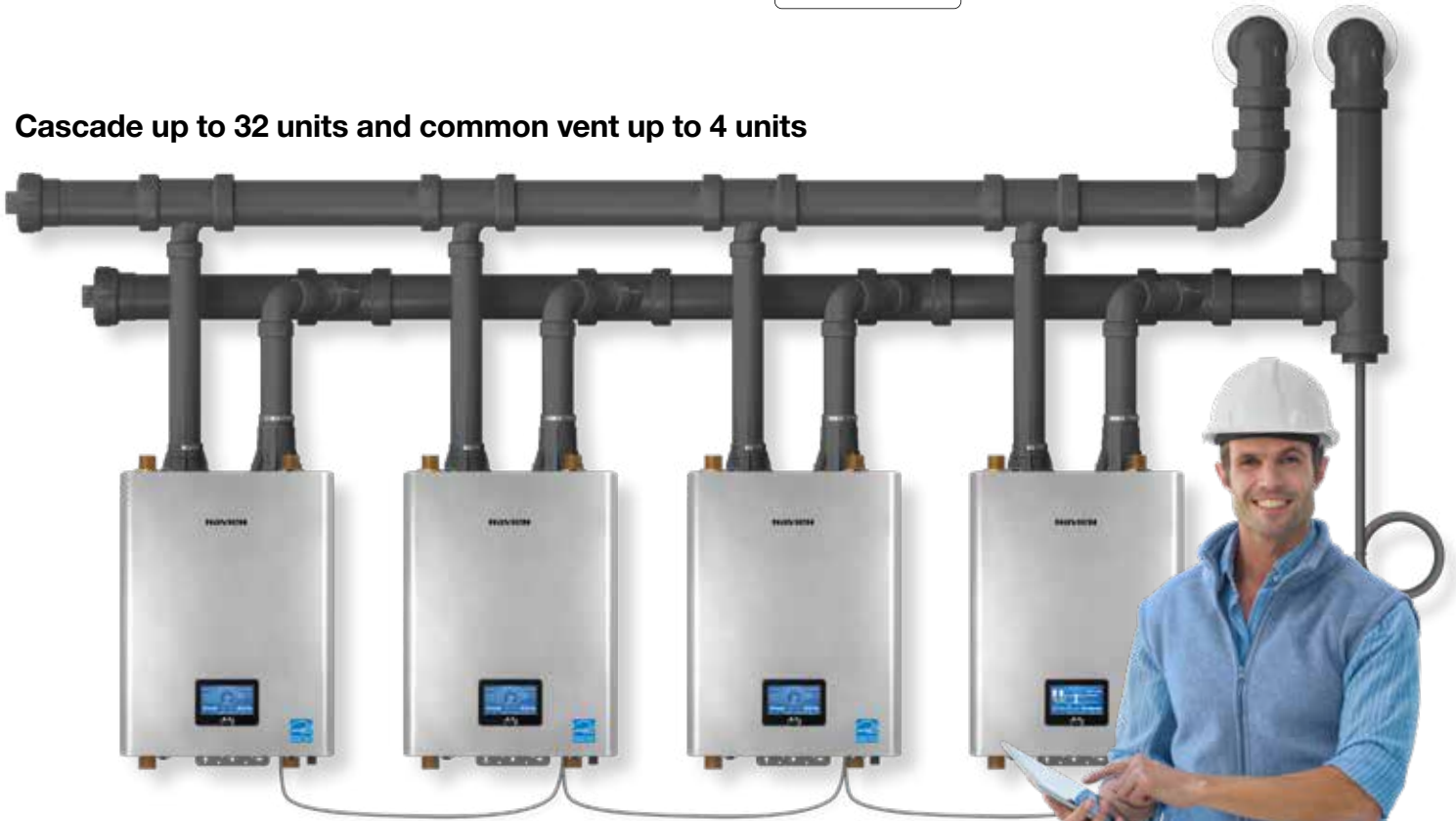

With Navien's cascade technology, when a unit gets up to capacity the next unit will start to help meet the hydronic heating requirements. This boiler sequence will continue until all units are generating the needed hydronic heat. The Navien cascade system also balances out the workload of each unit for longer life.

Top and bottom piping

Easy pipe connections for floor or wall-hung installations.

Multiple venting options. Low exhaust gas temperatures allow use of PVC, CPVC, polypropylene (rigid and flexible) and stainless steel venting reducing installation time and costs. System can use 3" venting for up to 60', or up to 150' with 4" venting.

Dual Venturi and field gas convertibility.

Dual Venturi system creates better combustion control and turndown ratio. Orifice for easy field gas convertibility from NG to LP. Conversion kits included with every NFB-C series boiler.



Low gas pressure operation. Negative pressure regulating gas valve ensures maximum performance all the way down to 3.5" of water column on natural gas and 8" of water column on propane gas.

Advanced controls. All system setup, operations and troubleshooting available at your fingertips with the 7" touch color display panel. Intuitive text information makes everything easier.

Built-in hardware connects boiler pump & 3 zone pumps. All integrated into the NFB-C circuit board. Also includes a DHW priority zone.

Patented stainless steel fire tube HX

Navien's ASME-certified, "H" stamped stainless steel fire tube heat exchangers are in-house designed and built by the latest in robotic and automated technology, reducing high stress point weld failures common on other boilers.

Low profile burner removes easily and improves serviceability, unlike other's bulky cylindrical burners.

Innovative heat exchanger design allows water to fill to the top eliminating extra combustion chamber insulation and improving durability.

EPP exterior insulation reduces heat loss and increases efficiency.

One-piece combustion chamber minimizes number of weld points prone to corrosion.

Turbulators inside the tubes increase structural strength and create a cyclone effect of flue gases maximizing heat transfer and efficiency.

New diaphragm design optimizes water flow and improves performance.

Non-metallic drain pan prevents corrosion caused by acidic condensate, unlike competitor's metal pans.

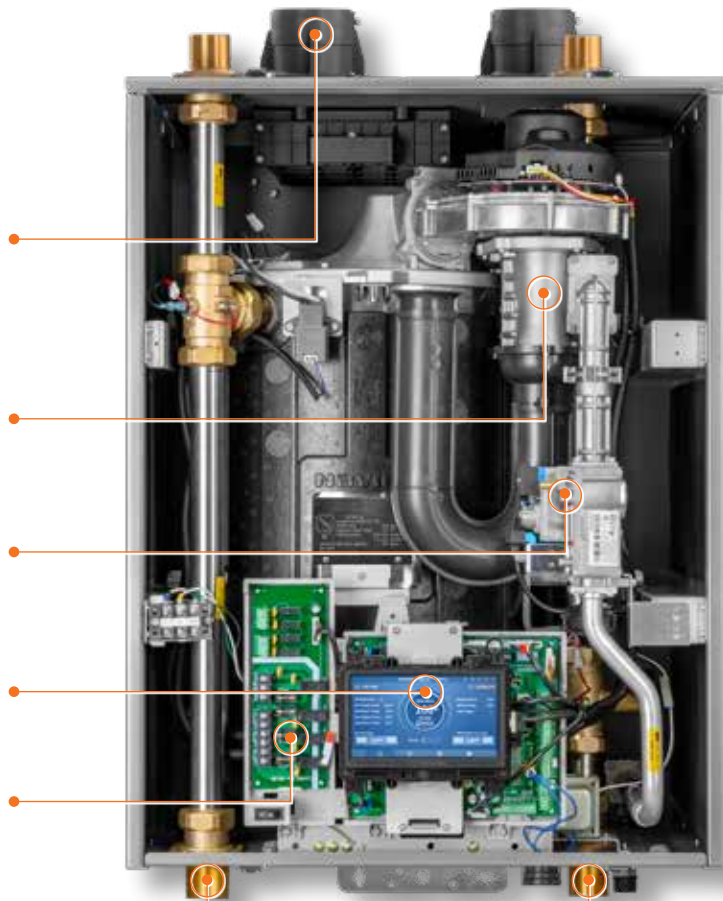

Top and bottom piping

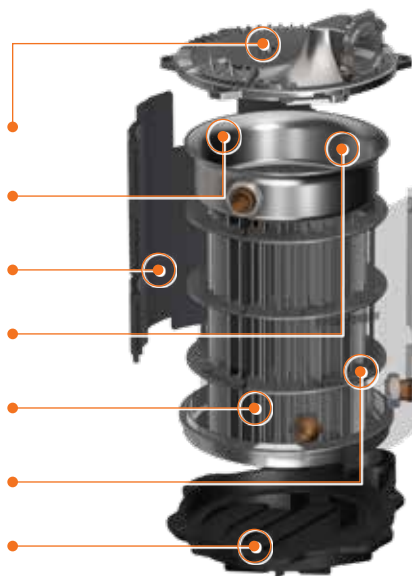

NFB-C



NFB-C Series

NAVIEN CONDENSING COMMERCIAL FIRE TUBE BOILERS

NFB-C

Every Navien NFB-C boiler comes with all these extra components... right in the box



Caps with gaskets

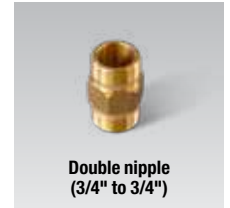

Double nipple
(3/4" to 3/4")



3" vent caps (2)

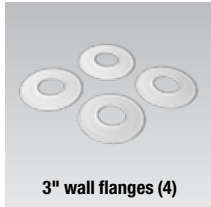

3" wall flanges (4)



Air vent



Wall mounting bracket

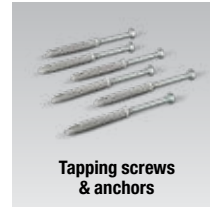

Tapping screws
& anchors



50 PSI
pressure relief valve



NG/LP conversion kits



Outdoor temp sensor
& cable



PRV and air vent
adapter & clip



Condensate trap

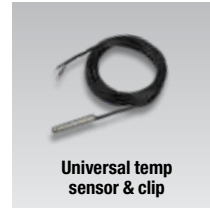

Universal temp
sensor & clip



Air vent bushing
(1-1/2" to 3/4")



T H E L E A D E R I N C O N D E N S I N G T E C H N O L O G Y

NFB-C Series commercial boiler accessories



Navilink®
Wi-Fi control
 PBCM-AS-001
Expansion cable
 GXXX001659



Navilink®
Wi-Fi control
 PBCM-AS-002



NFB-C common vent collar kit
 Required for cascade/
 common vent installations.
 30022799A
 Includes cascade cable GXXX000546
 and common vent collar damper.



Pressure relief valves
75 PSI
 GXXX001931
150 PSI
 GXXX001946



Universal temperature sensor
 Designed to sense supply, return or
 tank water temperature. Works with all
 NFB-C series boilers.
 GXXX001769



Commercial neutralizer
 Designed to neutralize the condensate
 of up to 16 NFB-C series units.
 GXXX001325
Commercial replacement media
 GXXX001329



Light commercial neutralizer
 Designed to neutralize the condensate
 of up to 6 NFB-C series units.
 GXXX001324
Light commercial replacement media
 GXXX001328



SmartZone+
pump controller
 2 Zones: PFMZ-02P-001
 3 Zones: PFMZ-03P-001
 4 Zones: PFMZ-04P-001
 6 Zones: PFMZ-06P-001



**Modbus/BACnet gateway
 & power adaptor**
 GXXX001932



LonWorks gateway & power adaptor
 GXXX001933



Ready-Link®
communication cable
 GXXX000546

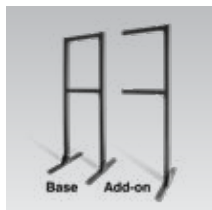

Ready-Link®
rack
Base (V3)
 GFFMKDIZUS-005
Add-on (V3)
 GFFMKDIZUS-006

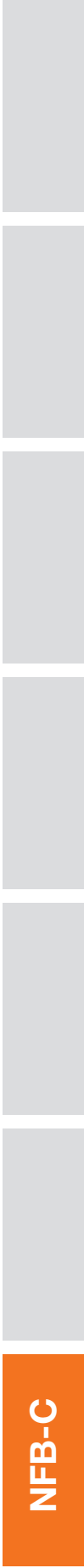



NFB-C

NFB-C Series

NAVIEN CONDENSING COMMERCIAL FIRE TUBE BOILERS



Dimensions

NFB-301C

Overhead View

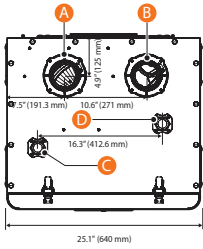

25.1" (640 mm)

Front View

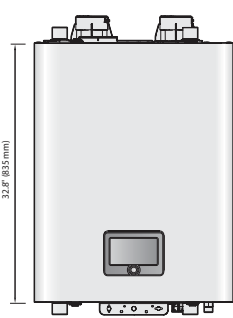

32.8" (833 mm)

Supply Connections

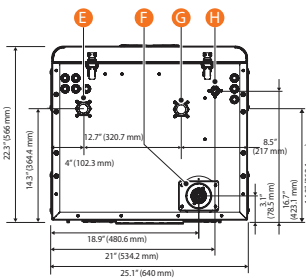

22.3" (566 mm)

Connection Size
NFB-301C

- A Air Intake \varnothing 3"
- B Exhaust Gas Vent \varnothing 3"
- C PRV-Air Vent Connection (Optional Heating Supply) \varnothing 1-1/4"
- D Optional Heating Return \varnothing 1-1/4"
- E Heating Supply \varnothing 1-1/4"
- F Condensate Outlet \varnothing 3/4"
- G Heating Return \varnothing 1-1/4"
- H Gas Connection \varnothing 3/4"

NFB-399C

Overhead View

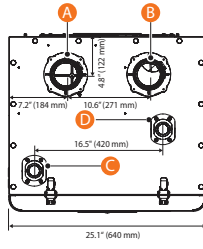

25.1" (640 mm)

Front View

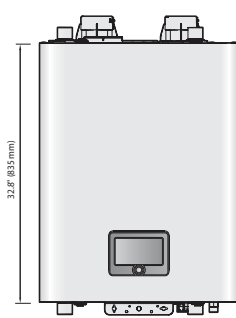

32.8" (833 mm)

Supply Connections

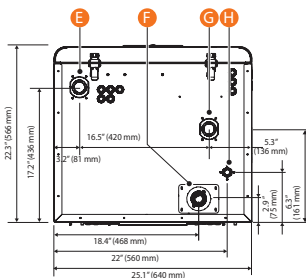

22.3" (566 mm)

Connection Size
NFB-399C

- A Air Intake \varnothing 3"
- B Exhaust Gas Vent \varnothing 3"
- C PRV-Air Vent Connection (Optional Heating Supply) \varnothing 1-1/2"
- D Optional Heating Return \varnothing 1-1/2"
- E Heating Supply \varnothing 1-1/2"
- F Condensate Outlet \varnothing 3/4"
- G Heating Return \varnothing 1-1/2"
- H Gas Connection \varnothing 3/4"

Specifications

Item	Model	
	NFB-301C	NFB-399C
Dimensions	25.1" W x 22.3" D x 32.8" H	
Boiler weight	Empty	243 lb (110 kg)
	With water	307 lb (139 kg)
Installation type	Indoor wall-hung	
Venting type	Forced draft direct vent and non-direct vent (single pipe)	
Ignition	Electronic ignition	
Natural Gas supply pressure (from source)	3.5" to 10.5" WC	
Propane Gas supply pressure (from source)	8.0" to 13.5" WC	
Natural Gas manifold pressure	-0.06" to -0.87" WC	-0.03" to -1.85" WC
Propane Gas manifold pressure	-0.01" to -0.92" WC	-0.01" to -0.90" WC
Gas connection size	3/4" NPT	
Power supply	Main supply	120V AC, 60Hz
	Maximum power consumption	Less than 12 amperes
Materials	Casing	Cold-rolled carbon steel
	Heat exchangers	Stainless steel
Venting	Exhaust	3" or 4" PVC, CPVC, PP and SS 3" or 4" special gas vent type BH (Class III, A/B/C)
	Intake	3" or 4" PVC, CPVC, PP and SS 3" or 4" special gas vent type BH (Class III, A/B/C)
	Vent clearance	0" to combustibles
Safety devices	Flame rod, APS, LWCO, water temperature high limit switch, exhaust temperature high limit sensor, water pressure sensor	

Navien reserves the right to change specifications at any time without prior notice. Please refer to www.NavienInc.com to verify you have the most current information.



Ratings

Navien Commercial Condensing Boiler Space Heating Ratings					Other Specifications			
Model Number ¹	Heating input (BTU/h)		Heating capacity ² (BTU/h)	Net AHRI rating water ³ (BTU/h)	Thermal Efficiency ² (%)	Boiler water content (gallons)	Water pressure (PSI)	Water connection size (supply, return)
	Min	Max						
NFB-301C	20,000	301,000	293,000	255,000	97.5	7.6	12-160	1-1/4 in NPT
NFB-399C	26,000	399,000	389,000	338,000	97.5	9.6		1-1/2 in NPT

¹ Ratings are the same for Natural Gas models converted to Propane use.

² Based on U.S. Department of Energy (DOE) test procedures.

³ The NET AHRI Water Ratings shown are based on a piping and pickup allowance of 1.15. Consult Navien before selecting a boiler for installations having unusual piping and pickup requirements, such as intermittent system operation, extensive piping systems, etc.

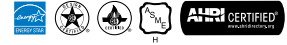

Navien certification summary

Item	Model	
	NFB-301C	NFB-399C
Product Approvals		
CSA	Yes	Yes
SCAQMD 1146.2 (NOx <20 ppm)	Yes	Yes
ASME	Yes "H" stamp	Yes "H" stamp
AHRI Number	201925233	201928625
Energy Star	Yes	Yes
Space Heating Ratings		
Thermal Efficiency %	97.5	97.5
Space Heating Gross Output, BTU/h	293,000	389,000

Input

Model	Heating (BTU/h)	TDR
NFB-301C	20,000–301,000	15:1*
NFB-399C	26,000–399,000	15:1*

*15:1 single boiler; 10:1 individual boilers when cascaded.

Temperature setting range

Item	Temperature Setting Range	Remarks
Space Heating	Supply	Actual supply and return temperatures vary depending on the selected outdoor reset curve.
	Return	

Warranty

Type	Residential Applications	Commercial Applications
Heat exchanger	15 years limited*	10 years
Parts	5 years	3 years
Labor	1 year	1 year

*12 years full plus 3 years prorated.

For complete details please refer to the full warranty at Navieninc.com.



PeakFlow[®] SCALE PREVENTION SYSTEMS

Navien PeakFlow[®] chemical free and salt free anti-scale water treatment products for your complete water supply system

Navien PeakFlow systems have been protecting Navien tankless water heaters and combi-boilers from damaging lime/calcium deposits in their products for many years. This advanced technology is now available to protect your complete water supply system for residential and commercial applications.



DHW piping



Tankless water heater heat exchanger



Water heater outlet



PeakFlow[®]S Standard
GPWC1101AC001



PeakFlow[®]C Commercial
GPWC5101AC001



PeakFlow[®]A Advanced
GPWC3101AC001





Specifications

Warranty

Eco-friendly and economical residential and commercial solutions

- Prevents scale formation
- No chemical
- Low maintenance
- Low cost
- Easier on the planet

Item		Model		
		PeakFlow S Standard	PeakFlow A Advanced	PeakFlow C Commercial
Flow Rate	Maximum	6 GPM (23 L/m)	10 GPM (38 L/m)	20 GPM (76 L/m)
	Continuous	4 GPM (15 L/m)	6 GPM (23 L/m)	16 GPM (60 L/m)
Maximum pressure		90 PSI (6.2 bar)	90 PSI (6.2 bar)	90 PSI (6.2 bar)
Temperature	Maximum	100°F (38°C)	122°F (50°C)	122°F (50°C)
	Minimum	40°F (5°C)	37°F (3°C)	37°F (3°C)
Inlet/outlet connections		3/4" NPT	1" NPT	1-1/4" NPT
Media replacement period		2 years	5 years	5 years
Unit size (W x H)		7" x 13-1/2"	6 1/2" x 22 1/2"	12" x 57"
Certification		IAPMO R&T certified to NSF 61 Standard		

Type	Parts
PeakFlow S	1 year
PeakFlow A	1 year
PeakFlow C	1 year

Note: Assembled with NSF-certified parts.

PeakFlow S Residential Installation

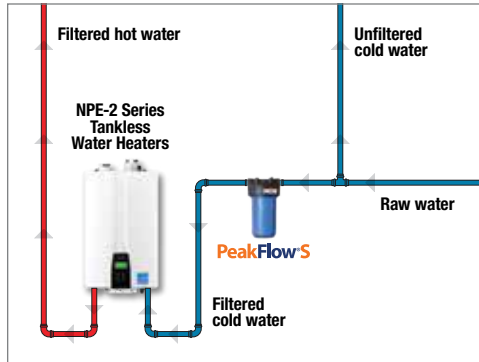

PeakFlow A Commercial Installation

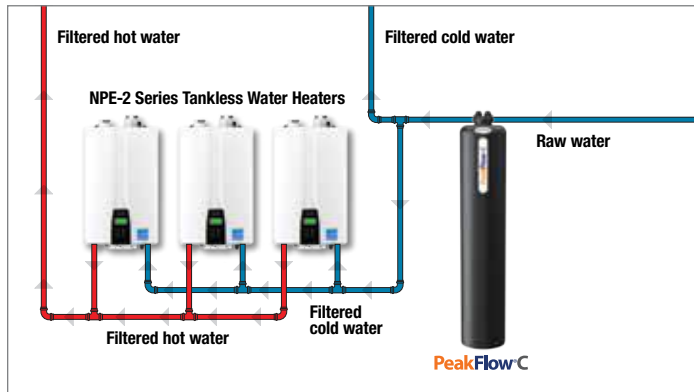
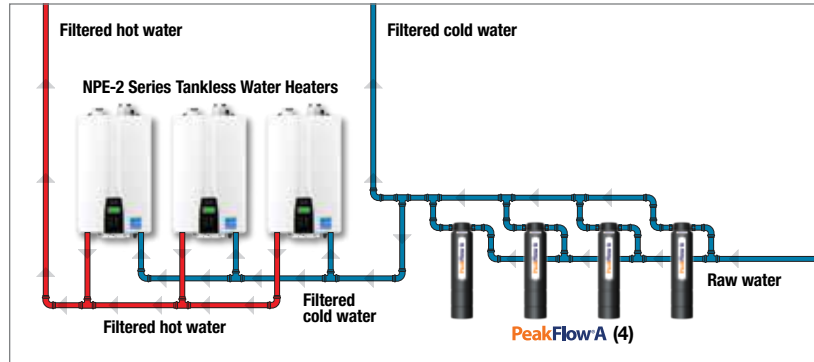

PeakFlow C Commercial Installation

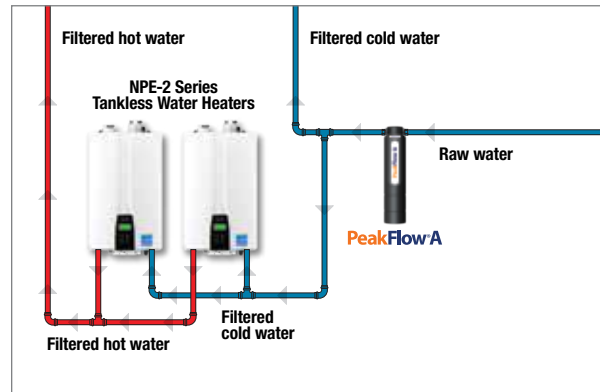

PeakFlow A Residential/Commercial Installation



Lined area for notes.

GLOBAL Technology LOCAL Solutions

Contact your local Navien representative to learn how Navien technology is bringing the most energy efficient hot water and heating solutions to homes and businesses in North America. Besides supplying these innovative systems, Navien provides extensive field support, webinars and training events to builders, architects and contractors



Navien Inc., 20 Goodyear, Irvine, CA 92618 800-519-8794 navieninc.com



T H E L E A D E R I N C O N D E N S I N G T E C H N O L O G Y